



Computer & Information and Communication Technology

First grade preparatory



Second Term

2025-2026

Preparation and Review Committee

<p>Mr. Waseem Salah El-Din El-Manzlawy Manager of the Educational Computer Department Within the General Administration for Curriculum Monitoring and Evaluation</p>	<p>Mr. Tamer Abdel Mohsen Mansour Manager of the Educational Computer Department Within the General Administration for Curriculum Monitoring and Evaluation</p>
---	--

Dr. Mohamed Abdul Tawab Abdullah

Expert teacher at STEM schools

<p>Dr. Abeer Hamed Ahmed Computer Education Consultant Within the General Administration for Curriculum Monitoring and Evaluation</p>	<p>Dr. Taher Abd Elhamed ElAdly Head of ICT Department the General Administration of Curriculum Planning and Formulation</p>
--	---

<p>Prof. Al-Gharib Zaher Ismail Educational Technology Professor, Faculty of Education Mansoura University</p>	<p>Prof. Mohamed Fahmy Tolba Computing and Information Professor, Faculty of Computing Ain Shams University</p>
---	--

Supervised by

Dr. Akram Hassan

Assistant Minister for Curriculum Development

Supervisor of the Central Curriculum Development Division

Contents

S	Topics	Page
	Chapter Two (Artificial Intelligence and Programming)	
1	Lesson 1: Artificial Intelligence Applications	5
2	Lesson 2: Sensors	17
3	Lesson 3: Robot	27
4	Lesson 4: Scratch	37
5	Lesson 5: Sprites Area in Scratch	50
6	Lesson 6: Principles of Python	62
7	Lesson 7: Variables in Python	69

Chapter Two



**Artificial Intelligence
and Programming**

Lesson 1

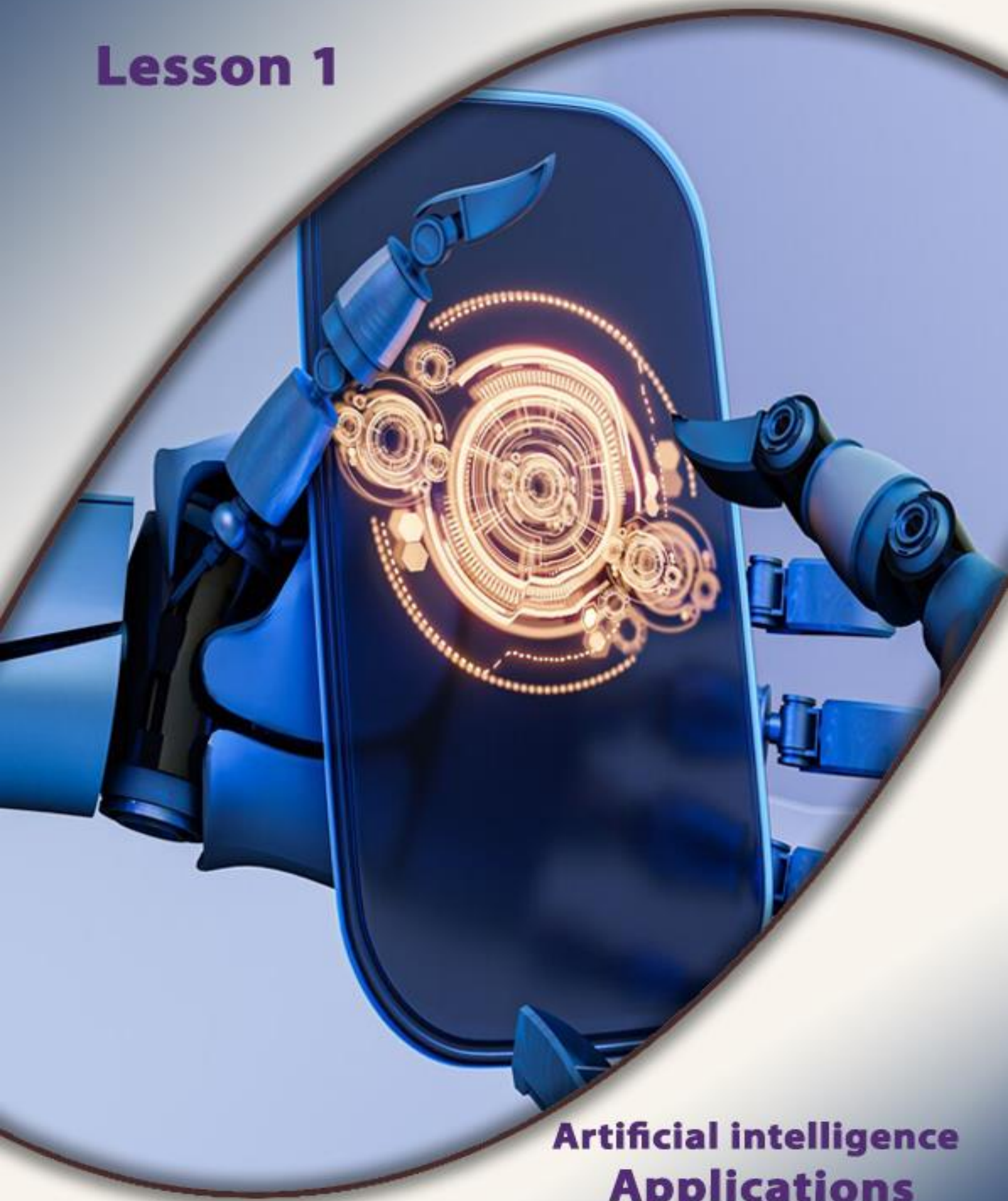

**Artificial intelligence
Applications**

Lesson 1

Artificial Intelligence Applications

Objective :

By the end of the lesson, I will be able to:

- List types of artificial intelligence
- Review some practical applications of artificial intelligence.
- Suggest the largest number of ideas for the uses of artificial intelligence in our lives.

After the lesson, check the correct box:

I can...

- | | | |
|------------------------------------|-----------------------------|---|
| <input type="checkbox"/> Very good | <input type="checkbox"/> Ok | <input type="checkbox"/> Need more work |
| <input type="checkbox"/> Very good | <input type="checkbox"/> Ok | <input type="checkbox"/> Need more work |
| <input type="checkbox"/> Very good | <input type="checkbox"/> Ok | <input type="checkbox"/> Need more work |

Engage:

How has artificial intelligence helped us improve services in life? Explain that.

Learn

In previous years in the primary stage, you studied the definition of artificial intelligence and some of its uses in our daily lives. In this lesson, we will discuss the types of artificial intelligence and its applications in our lives.

Types of Artificial Intelligence:

Artificial intelligence is not just one type, but there are many and varied types. Imagine that we have a large garden full of different flowers, each flower has a different shape and color, and so is the case with artificial intelligence.

- **Narrow AI:**

This type of artificial intelligence focuses on performing a specific task, such as recognizing faces or translating languages. Another example is a robot that can play chess brilliantly, but it cannot do anything else.

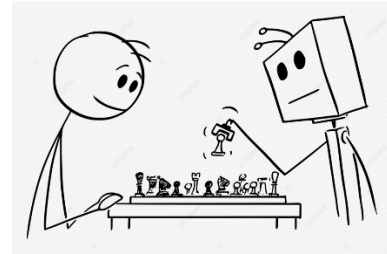

- **General artificial intelligence (GAI):**

This type of artificial intelligence is more advanced, and can perform any task that a human can do. **Example:** A robot that completely mimics a human, as it can think, innovate, solve complex problems, learn, and adapt to different situations.

- **Super artificial intelligence (SAI):**



This type of artificial intelligence is the most advanced; it can solve problems that are difficult for humans to solve easily, and discover new things that we have never imagined before.

Activity:

Dear student, with the help of your teacher and in cooperation with your colleagues, search for the uses and the applications of artificial intelligence in our daily lives?

Applications of artificial intelligence in daily life:

<ul style="list-style-type: none"> ● Personal Assistant: Do you have a friend who talks to you, answers your questions, and performs tasks? This is the personal assistant like (Siri) or (Alexa), it uses artificial intelligence to understand your commands and perform them. 	
<ul style="list-style-type: none"> ● Smart Games: Do you play video games? Some of these games use artificial intelligence to make the game more fun and challenging, as the characters in the game can learn from their mistakes and become smarter. 	

<ul style="list-style-type: none"> • Smart Cars: Have you ever imagined a car driving itself without a driver? This is the dream of the future that is getting closer to being realized thanks to artificial intelligence. 	
<ul style="list-style-type: none"> • Digital Doctors: Doctors use artificial intelligence to help them diagnose and treat diseases faster and more accurately. 	
<ul style="list-style-type: none"> • Instant Translator: Have you traveled to another country and spoken a different language? Artificial intelligence can translate words and sentences instantly, making it easier for people to communicate. 	
<ul style="list-style-type: none"> • Smart Shopping: Have you noticed that shopping sites offer you suggestions for products that you might like? This is thanks to artificial intelligence that analyzes your previous purchasing behavior. 	

Artificial Intelligence Fields:

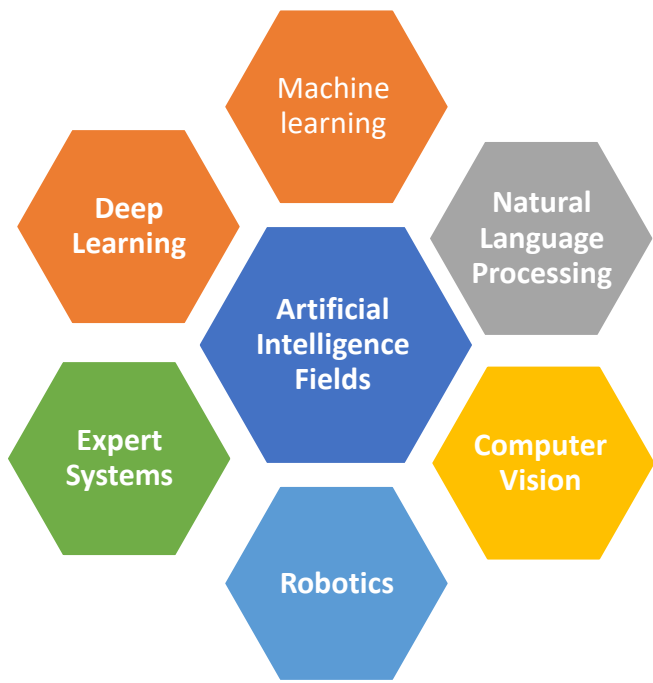

Artificial Intelligence Fields

1. Machine Learning - Learning from Mistakes:

- AI has to learn new things, the more we show it a picture of a cat, the more it learns to name it, and the more we play a game with it, the smarter it becomes, this is called **Machine Learning**, and it is similar to when you learn to ride a bike, the more you fall, the better you learn how to balance.

2. Natural Language Processing - Understanding Languages:

- Can you imagine talking to your computer as if it were a friend? It understands our different languages and can answer our questions. This is **Natural Language Processing**, and it is like an intelligent language translator as it understands written and spoken human language, interprets it, and learns to "speak" human language.

3. Computer Vision - Sees the World:

- AI can look at a picture and tell you everything in it, and it can find your face in a crowded picture, and distinguish between pictures of different animals, which is called Computer Vision.

4. Robotics:

There are smart robots that do many tasks such as cleaning the house, playing chess, or performing complex and precise surgery, and they have the ability to work with great accuracy even in environments that are dangerous to humans.

5. Simulation of human thinking and decision-making - Expert Systems:

Artificial intelligence can solve complex problems and make difficult decisions. This is the field of **expert systems**. It is similar to an intelligent doctor who can diagnose diseases.

6. Simulation of human learning - Deep Learning:

Deep learning aims to enable computer systems to learn complex tasks in a way similar to the way humans learn. Artificial intelligence has a mind similar to the human mind. It uses this mind to learn things very quickly. Deep learning relies mainly on **neural networks and deep learning**.

Create intelligent models to recognize images, sounds, and movements using machine learning (Teachable Machine):

Imagine if you could teach a computer to recognize objects in the same way you learn! This is exactly what Teachable Machine does, an easy-to-use tool that helps you create intelligent models to recognize images, sounds, and movements.

Activity:

Dear student, with the help of your teacher and in cooperation with your colleagues, download the Teachable Machine website.

Note: It is preferable to update your internet browser and work on the Microsoft Edge browser.

Click on the following link to enter the website <https://teachablemachine.withgoogle.com/>

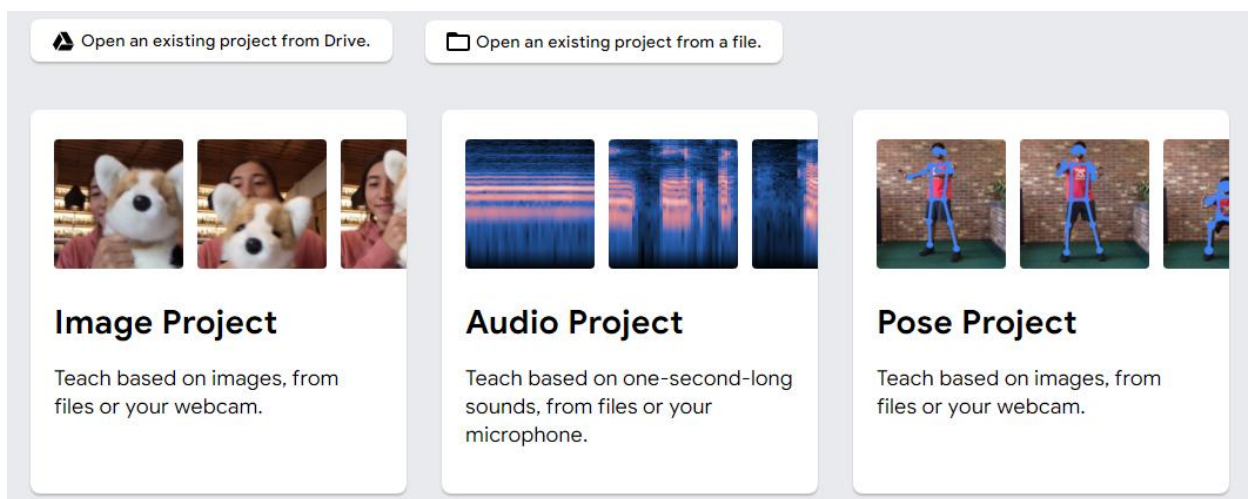

Home screen layout of the site

Model Building Training:

Imagine that you are training a young child to do new things! First, you need to teach him the names of things.

- You show the young child a picture of a cat and say, “This is a cat,” then you show him a picture of a dog and say, “This is a dog.”
- You are telling the child what things he sees, just as you teach him the names of letters and numbers.

- After the young child sees a lot of pictures and hears names, his little brain starts to understand the difference between a cat and a dog, just like when scientists try to train a computer to understand pictures and sounds.
- The child has learned so well that he can now tell the difference between a cat and a dog on his own, and in the same way, the computer has learned to recognize different things, and we can use it for a lot of fun things!

Imagine that we want to teach the computer to recognize numbers. We can start by giving him pictures of numbers from “0-9,” and telling him what number is in each picture. After a while, the computer will be able to look at any number and tell us what it is.

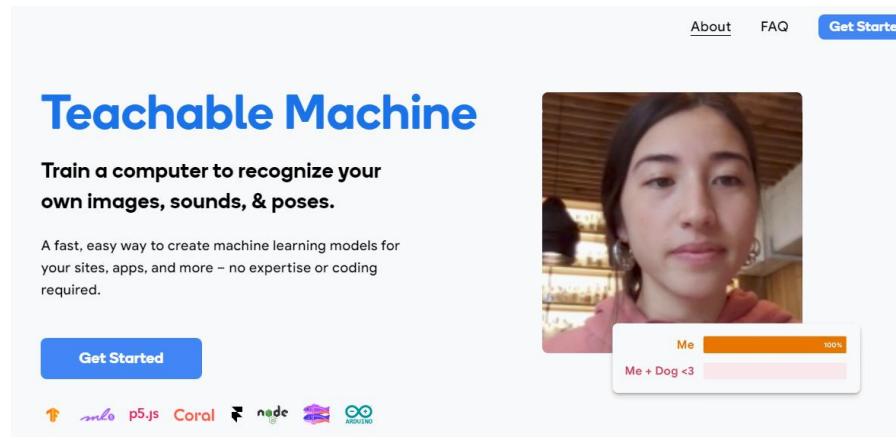

Website login window layout

 <p>Image Project</p> <p>Teach based on images, from files or your webcam.</p>	<p>Ready to explore the world of photography? Our first project will take you on an exciting journey!</p>
<p>The images of numbers from "0-9" are prepared in the form of images of files stored on the computer.</p>	

New Image Project

Standard image model

Best for most uses

224x224px color images

Export to TensorFlow, TFLite, and TF.js

Model size: around 5mb

The screenshot shows the Teachable Machine interface. On the left, there are two class cards: 'Class 1' and 'Class 2'. Each class card has a title, an edit icon, and a section for 'Add Image Samples' with 'Webcam' and 'Upload' buttons. Below the class cards is a dashed box with the text 'Add a class'. In the center, there is a 'Training' panel with a 'Train Model' button and a dropdown menu currently set to 'Advanced'. On the right, there is a 'Preview' panel with an 'Export Model' button and a message: 'You must train a model on the left before you can preview it here.' Lines connect the 'Add Image Samples' sections to the 'Training' panel, and the 'Training' panel to the 'Preview' panel.

1. Classification that includes a group of images that belong to a specific category such as images of numbers "from 0-9" and another classification that includes images of alphabet letters.
2. Upload images of numbers in (Class1).

3. Open the camera, prepare images of numbers on paper boards" and have the model take them in (Class2),

Note: The images were provided to the model in the form of files or he takes them through the Web camera.

4. The artificial intelligence model is trained on the image categories that were given to it.

5. Add more image categories when needed, for example "adding special symbols".

6. After that, the model can be given an image that determines for us which category of images it follows.

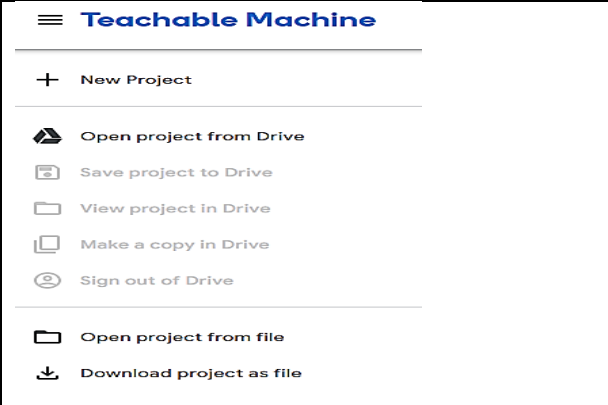
<p>Save the project:</p> <p>1- Save the project on Google Drive...</p> <p>2- Download the project to the device..</p>	 <p>The screenshot shows the 'Teachable Machine' interface. At the top, there is a hamburger menu icon followed by the text 'Teachable Machine'. Below this, there are several options: '+ New Project', 'Open project from Drive' (with a folder icon), 'Save project to Drive' (with a folder icon), 'View project in Drive' (with a folder icon), 'Make a copy in Drive' (with a folder icon), and 'Sign out of Drive' (with a person icon). A horizontal line separates these from the bottom options: 'Open project from file' (with a folder icon) and 'Download project as file' (with a download icon).</p>
--	--

Practical example:

Suppose you want to make a game where you control a character on the screen with your hand movement, here are the steps:

- **Training:** You record your hand in different positions (such as raising the hand, lowering it, moving it right and left).
- **Recognition:** Teachable Machine learns to associate each position of your hand with a specific movement of the character on the screen.
- **Game:** When you move your hand in front of the camera, the character on the screen moves according to what the computer has learned.

Example application:

- **Access the site:**

Open your browser and type "Teachable Machine" in the search bar, then access the site.

- **Select the training model:**

We find several options, choose the option related to image recognition (Image).

- **Prepare the camera:**

The site will ask you to choose to upload images (upLoad) or allow it to use your device's camera (web). Click on the camera (web) and make sure that the lighting is good and the camera background is simple so that the computer focuses on the movement of your hand.

- **Train the computer.**

- **Create Classes:**

Create at least two classes (Class1) and (Class2), for example (Class1) "Raised hand" and (Class2) "Shaky hand".

- **Record examples:** In front of each category, record several examples of the corresponding hand movement, for example, in front of the category "raised hand", raise your hand several times and each time raise it with a specific movement or a different shape, and so on in front of the category "shaky hand".
- **Review examples:** Make sure that the examples are clear and that the computer understands the difference between the two movements.
- **Training:** After you finish taking the pictures, click on the "Train Model" button to teach the computer these movements.
- **Test the model:** After you finish training, the site will ask you to test the model.
 - **Camera:** Point the camera at your hand and perform the movements you trained.
 - **Results:** You will see that the computer will try to guess the movement you are performing.
- **Save the model:** If you like the model, you can save it and use it in other projects.

Ideas for your projects:

- **Recognize faces:** Train the computer to recognize the faces of your friends and family.
- **Create a motion control game:** Use your body movements to control characters in a video game.
- **Image classification:** Teach the computer to classify images into different categories (such as animals, food, colors).
- **Create a robot that follows you:** Build a small robot that follows you wherever you go.

Learn by doing

Put a check mark (✓) in front of the correct sentence and a check mark (✗) in front of the incorrect sentence.

1. Artificial intelligence is only used in the video game industry. ()
2. Artificial intelligence can help doctors diagnose diseases. ()
3. Self-driving cars depend entirely on artificial intelligence. ()
4. Artificial intelligence can learn new things slowly. ()
5. Artificial intelligence is a science of computer science. ()
6. For artificial intelligence to become intelligent, it needs small amounts of information. ()
7. Artificial intelligence is only one type. ()
8. Narrow artificial intelligence can perform any task that a human can perform. ()
9. General artificial intelligence is more advanced. ()
10. General artificial intelligence focuses on performing a specific task. ()
11. Super artificial intelligence can solve specific problems. ()
12. Smart Games are used to make playing games more fun. ()
13. Instant Translator is used to facilitate communication between people. ()
14. Smart Shopping gives you suggestions for products you might like. ()
15. Natural language processing is like a machine language translator. ()
16. Robots are very good at doing a lot of things with great accuracy. ()

Self-assess

Go to the objectives at the beginning of the lesson.

Check the correct, I can..... box.

Lesson 2



Sensors

Lesson 2

Sensors

Objective:

By the end of the lesson, I will be able to:

- Mention the different types of sensors and their areas of use.
- List the importance of sensors in our modern life.
- Design a simple project based on the idea of sensors.

After the lesson, check the correct box: I can...

- | | | |
|------------------------------------|-----------------------------|---|
| <input type="checkbox"/> Very good | <input type="checkbox"/> Ok | <input type="checkbox"/> Need more work |
| <input type="checkbox"/> Very good | <input type="checkbox"/> Ok | <input type="checkbox"/> Need more work |
| <input type="checkbox"/> Very good | <input type="checkbox"/> Ok | <input type="checkbox"/> Need more work |

Engage:

How do sensors work? What devices have you seen or used in your life?



Learn

In this lesson, we will learn about one of the most important concepts in the world of modern technology, which is sensors. These simple devices play a major role in our daily lives, from their use in robots to their use in our smartphones, modern cars, and alarms.

We will learn together how these devices work and what their types are, and we will review real-life examples that help us understand how they work and how they are used in electronic devices and robots.

Sensors: They are devices that sense changes in the surrounding environment and convert them into signals so that machines and devices can understand them and make appropriate decisions based on them. They are considered the eyes and ears of machines.



How do sensors work?

Have you ever wondered how the sensation of light, heat, or sound is converted into numbers in a computer? Imagine that the sensor is a translator that translates those sensations (such as heat, light, or sound) into a language that the computer understands, which is the language of numbers. **Sensors work through 3 main**

steps:

- 1. Sensing:** Captures information from the surrounding environment (such as heat, light, or sound).
- 2. Signal Conversion:** Converts this information into electrical signals that can be read by electronic devices.
- 3. Transmission:** Signals are sent to another device to display the results or perform a specific operation. For example, a thermometer displays the temperature result on a digital screen.

The importance of sensors for robots:

Imagine robots without sensors, they would be like a person walking with their eyes closed and their ears covered, they cannot recognize what is happening around them or recognize those around them or how to behave, here comes the importance of sensors, they represent the "senses" of the robot, helping it to see, hear, sense, and even touch things around it.

- Types of robotic sensors:

There are many different types of sensors used in robots, and each type has a specific function.

Here are some examples:

- **Distance Sensors:** Measure the distance between the robot and surrounding obstacles, this helps the robot avoid collisions.
- **Light Sensors:** Used in robots that operate in places where light is variable, such as home robots, these sensors help the robot adapt to changing light conditions.
- **Sound Sensors:** These are used in robots that react to sounds, for example: robots that can respond to voice commands.

- **Motion Sensors:** These detect movement and changes in direction. These sensors help the robot navigate and interact with surrounding objects.
- **Special Sensors:** Such as temperature and humidity sensors.

Activity:

Dear student, with the help of your teacher and in cooperation with your colleagues, mention examples of electronic devices that use sensors?

Some examples of electronic devices that use sensors:

- **Vacuum cleaner robot:** uses sensors to avoid obstacles and clean under furniture.
- **Surgical robot:** uses precise sensors to perform surgeries.
- **Self-driving cars:** rely heavily on sensors to see the road and make decisions.

Activity:

Dear student, with the help of your teacher and in cooperation with your colleagues, discuss with your colleagues the types of distance sensors?

Types of distance sensors and examples of them:

The types of distance sensors used in robots and smart devices vary, and each type has its own advantages and uses. **Here is a detailed explanation of the types of these devices with illustrative examples:**

1- Ultrasonic Sensors:

- **Working principle:** These devices emit high-frequency sound waves, then receive the returning waves after they bounce off an object, and by measuring the time it takes for the wave to return, the distance to the object can be calculated.
- **Examples:**
 - **Vacuum cleaner robots:** These devices are used to locate furniture and obstacles to avoid colliding with them.
 - **Parking systems:** They help measure the distance between the car and surrounding obstacles.

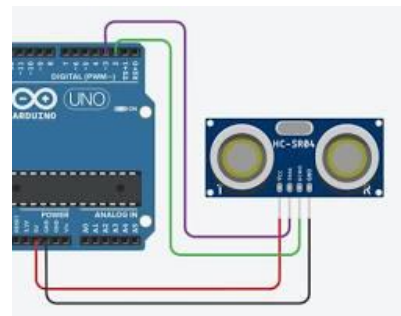

- **Fluid levels:** They are used to measure the level of fluids in tanks and reactors.

2- Laser Rangefinders:

- **Working principle:** These devices emit a laser beam and then measure the time it takes for the beam to return after bouncing off the object, and are characterized by high accuracy and a longer range compared to ultrasonic devices.
- **Examples:**
 - **3D laser scanners:** They are used to create 3D models of spaces.
 - **Ground scanning systems:** They are used in geological and archaeological surveys.
 - **Industrial measurement systems:** They are used to measure dimensions with high accuracy in various industries.



3- Visible Light Sensors:

- **Working principle:** These devices use digital cameras to analyze images and determine the distance to objects based on the size and distortion of the image.
- **Examples:**
 - **Self-driving car cameras:** used to determine the distance to other cars, pedestrians, and traffic signals.
 - **Industrial vision systems:** used to inspect products and identify errors.
 - **Augmented reality systems:** used to integrate digital elements with the real world.



4- Infrared Sensors:

- **Working principle:** These devices emit infrared rays and then receive the returning rays after they bounce off the object, widely used in consumer electronics.



- **Examples:**

- **Remote controls:** Infrared rays are used to communicate with electronic devices.
- **Non-contact thermometers:** Used to measure body temperature without the need for direct contact.

5- Time of Flight sensors:

- **Working principle:** It depends on measuring the time it takes for a light pulse to reach an object and return to it, characterized by high accuracy and high speed.
- **Examples:**
 - **3D sensors:** Used to create 3D models of objects.
 - **Motion tracking systems:** Used in video games and virtual reality systems.

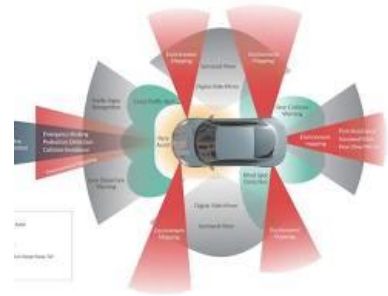

Activity:

Dear student, with the help of your teacher and in cooperation with your colleagues, discuss the factors for choosing the appropriate type of sensor?

Choosing the appropriate type of sensor depends on several factors, including:

- **Required range:** The maximum distance that the device must measure.
- **Required accuracy:** The required measurement accuracy.
- **Operating environment:** The environmental conditions in which the device will operate (lighting, temperature, humidity).
- **Cost:** The cost of the device and installation.

By choosing the appropriate device, robots and smart devices can interact with their environment more accurately and effectively.

Activity:

Dear student, with the help of your teacher and in cooperation with your colleagues, mention electronic devices that you use in your daily life and that depend on sensors in their work?

Daily applications of sensors:

Sensors are used daily in our lives, and the most prominent of these applications are:

- **In smartphones:** There are sensors that help in taking pictures, adjusting the lighting level, and even determining the location of the phone.
- **In modern cars:** Sensors are used to determine speed, warn of collisions, and help the driver park his car.
- **In smart homes:** Motion sensors turn on the lights automatically when someone enters the room.
- **Phone microphone:** It is a sound sensor that converts the sound you pick up into electrical signals that can be understood by the phone.
- **Motion sensor in games:** When you tilt your phone to the right or left while playing a game, the motion sensor is what tells the game to change the direction of the character.
- **Touch screen:** It is a group of small sensors that sense where your finger touches the screen.

Activity:

Dear student, with the help of your teacher and in cooperation with your colleagues - and with the help of the science teacher, use a temperature sensor.

Practical activity:

Required materials:

- Temperature sensor.
- A cup of hot water.
- A cup of cold water.

Steps:

1. Measure the temperature of the hot water using the temperature sensor.
2. Repeat the process with cold water.
3. Notice the difference in temperatures displayed on the device screen.

Learn by doing

Choose the correct answer from the following:

1. The main function of the sensor is

- A. Store data
- B. Capture environmental changes and convert them into signals
- C. Display images
- D. Produce sound

2. Sensors help robots to.....

- A. Teach them new languages
- B. Allow them to interact with their environment
- C. Increase their size
- D. Slow down their operations

3. A type of sensor is used to avoid obstacles.

- A. Light sensors
- B. Sound sensors
- C. Distance sensors
- D. Heat sensors

4. The first step in the operation of the sensor is

- A. Transmitting
- B. Displaying
- C. Sensing
- D. Transduction

5. are commonly used in remote controls.

- A. Ultrasonic sensors
- B. Infrared sensors
- C. Light sensors
- D. Motion sensors

6. Laser rangefinders are accurate because they use

- A. Sound waves
- B. Visible light
- C. High frequency waves
- D. Laser beams

7. A common application of sensors is the use of infrared in

- A. Smartphones
- B. Remote controls
- C. Vacuum cleaners
- D. 3D scanning

8. In which environment are light sensors useful?

- A. In dark rooms
- B. In places with variable lighting conditions
- C. In underwater environments
- D. In noisy factories

9. One of the sensors that are used to measure distance using high frequency sound waves is

- A. Ultrasonic sensors
- B. Laser rangefinders
- C. Infrared sensors
- D. Motion sensors

10. sensors are used to turn on lights when someone enters the room.

- A. Smartphone
- B. Smart car
- C. Smart Home Lighting System
- D. Smart Watch

11. is used for non-contact temperature measurement.

- A. Ultrasonic sensor
- B. Infrared sensor
- C. Light sensor
- D. Motion sensor

12. is the main purpose of the signal conversion step in sensors.

- A. Display the results
- B. Send the signals to another device
- C. Convert the information into electrical signals
- D. Turn off the sensor

13. helps cars determine the distance to other vehicles.

- A. Sound sensors
- B. Light sensors
- C. Infrared sensors
- D. Distance sensors

14. is the practical use of motion sensors in games.

- A. Change the volume
- B. Adjust the brightness of the screen
- C. Track the movements of players
- D. Improve the sound quality

15. Factors that determine the choice of a sensor for a particular application..... .

- A. Brand of the device
- B. Color of the device
- C. Environment and required accuracy
- D. Size of the device

Lesson 3



Robot

Lesson 3

Robots

Objectives:

By the end of the lesson, I will be able to:

- Explain the concept of robot.
- List the types of robots and their functions.
- Suggest the largest number of ideas for the uses of robots in our lives.

After the lesson, check the correct box:

I can...

- | | | |
|------------------------------------|-----------------------------|---|
| <input type="checkbox"/> Very good | <input type="checkbox"/> Ok | <input type="checkbox"/> Need more work |
| <input type="checkbox"/> Very good | <input type="checkbox"/> Ok | <input type="checkbox"/> Need more work |
| <input type="checkbox"/> Very good | <input type="checkbox"/> Ok | <input type="checkbox"/> Need more work |

Engage:

What is a robot? What functions can a robot perform? Explain?

Learn

The world is full of amazing robots that can do incredible things! Can you imagine a robot that can clean your room, another that can help you with your daily tasks? Or maybe a small robot that runs and plays with you like a pet! Robots can help us in our daily lives and in various fields.

Definition of Robot:

A robot is a device that can be programmed to perform a set of specific tasks automatically. The robot can move, sense (via sensors), and interact with its surroundings and can be used in environments that require precision and speed of performance.

Example: When we see a vacuum cleaner moving by itself in the house to clean the floor, this is a type of robot that works independently.

1- Types of robots: There are several types of robots, including:

- **Industrial robots:**

They are robots used in factories, and they can perform work with high accuracy, such as robots that work in car production plants on production lines quickly and accurately.

- **Home robots:**

These robots are found in homes, cleaning robots such as Roomba that help clean floors without any human effort, such as smart vacuums.



- **Medical robots:**

Medical robots help doctors perform surgeries, and they can be very accurate.

- **Educational robots:**

These robots are used in schools to teach students how to program and technology, such as LEGO Mindstorms robots that can be programmed to perform specific tasks, to help students and to be an aid to the teacher.

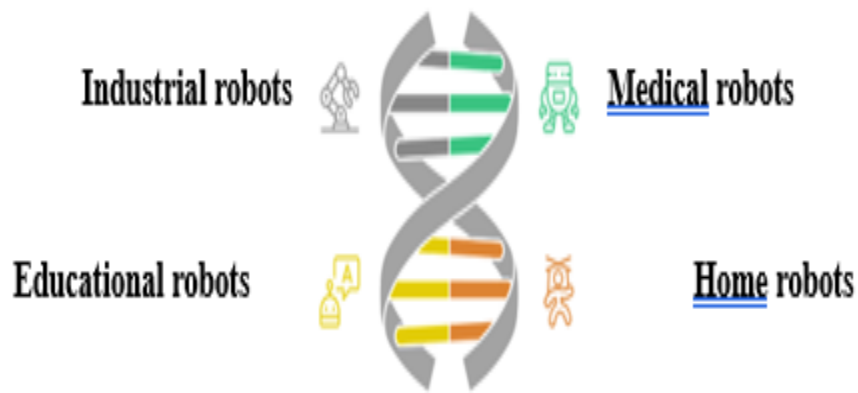

Types of Robots

Activity:

Dear student, with the help of your teacher and in cooperation with your colleagues, discuss with your colleagues the components of the robot.

2- Robot components:

- **Structure**

The structure is the main part that carries all the components of the robot. It can be made of different materials such as metal, plastic, or carbon. The design of the structure affects the weight of the robot and its ability to move.

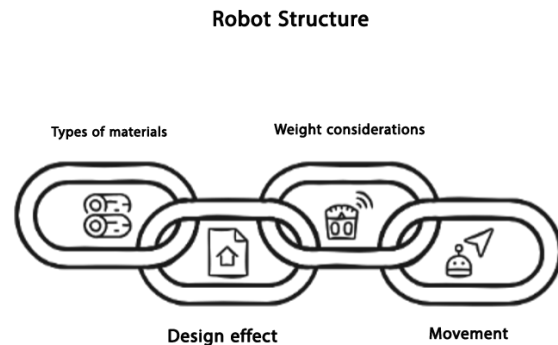

- **Sensors**

Sensors are the senses of a robot. Just as we use our eyes to see and our ears to hear, a robot uses sensors to pick up information from its surroundings. Some examples of sensors are:

- **Sound sensors:** pick up and analyze sounds.
- **Cameras:** help robots “see” things in front of them.

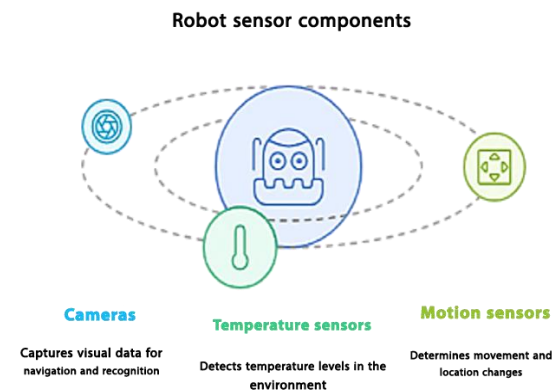

- **Motors**

Motors are used to move parts of a robot. There are different types of motors, such as electric motors and pneumatic motors, each with its own uses. Motors are the industrial muscles of robots. Thanks to motors (**actuators**), robots can move and **execute** commands.

- **Motors:** make robots move.
- **Robotic arm:** used in factories to move objects with precision.

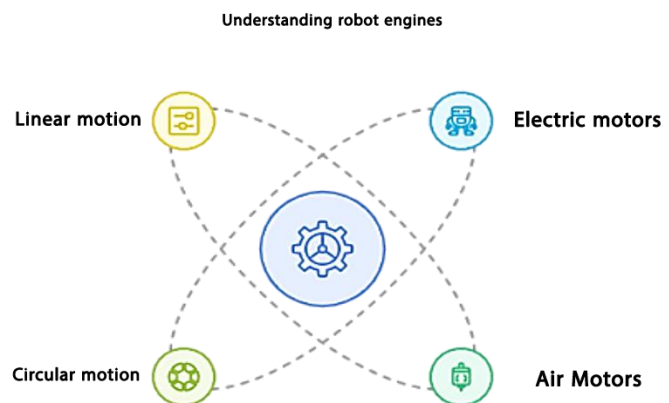

- **Controller:**

- The controller is the “brain” of the robot, processing the data collected by the sensors and issuing commands to the motors.

The controller can be as simple as electronic circuits or as

complex as microcomputers. Just as our brain thinks when we decide to move, the processor makes the decisions necessary to move the robot.

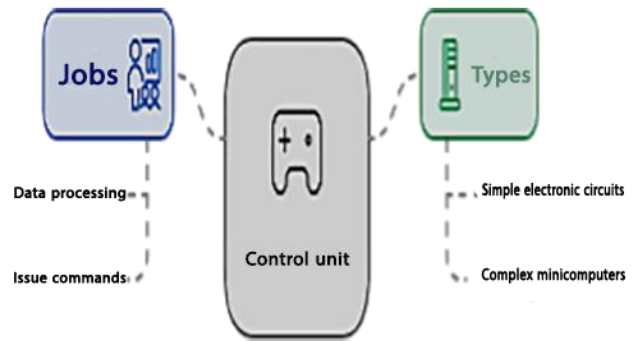

- **Power Source:**

Robots need a power source to operate. Power sources can be batteries, solar cells, or even direct electrical power sources. The choice of power source depends on the type of robot and the required operating time.

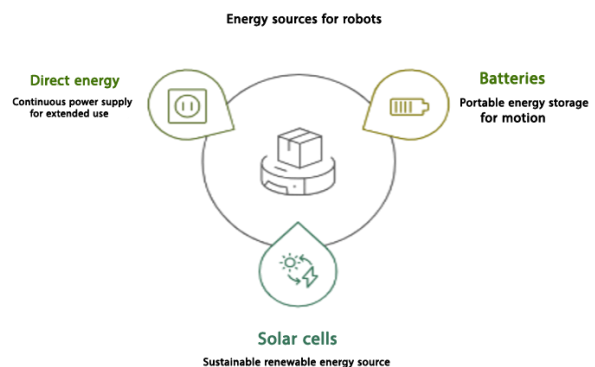

- **Software:**

Software is what makes a robot “smart.” Software includes algorithms that determine how the robot responds to information it receives from sensors.

Software can range from simple programs to complex artificial intelligence systems.

Integrating software and sensors into robots

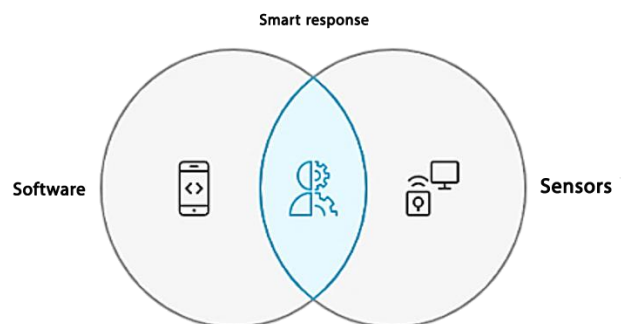

- **Communication tools:**

- Robots use communication tools to interact with users or other robots. These tools can include Bluetooth, Wi-Fi, or other communication technologies.

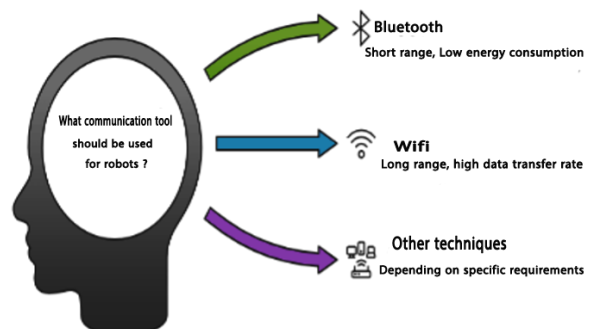

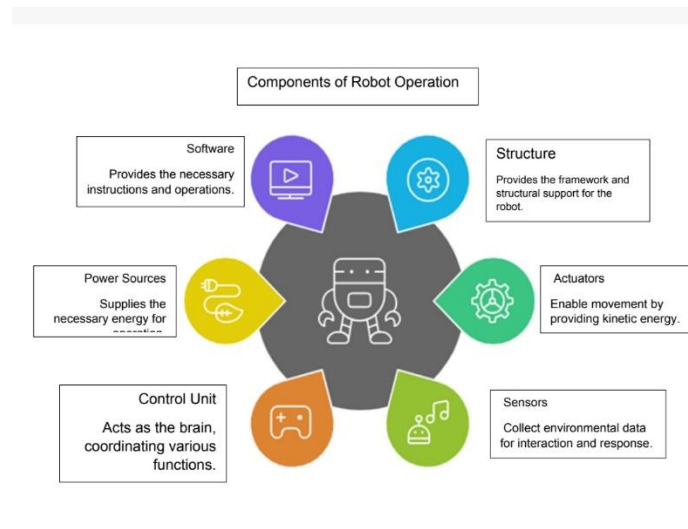

Example: A home robot, such as a robot vacuum cleaner, has sensors to avoid collisions with furniture and room walls.

3- Areas of use of robots:

Robots have become part of our daily lives and are used in several fields, such as medicine, industry, and education.

For example, in hospitals, there are robots that perform precise surgeries, while in factories, they help manufacture cars. **Robots have many applications in different fields, including:**

- **Industry:** Improving productivity and reducing human errors.
- **Healthcare:** Assisting doctors in surgeries or providing care for patients.
- **Education:** Providing interactive educational experiences for students.
- **Agriculture:** Using robots in precision agriculture to increase crops and reduce waste.

Activity:

Dear student, with the help of your teacher and in cooperation with your colleagues, discuss what are the challenges facing robotics technology?

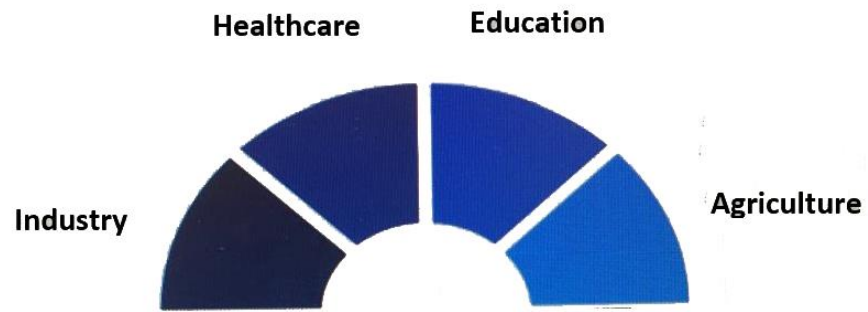

4- Challenges

Despite the many benefits of robotics, there are challenges facing this technology, such as:

- **Safety:** The need to ensure the safety of robots during work.
- **Employment:** Concern that robots may replace human labor.
- **Ethics:** Issues related to robots and their impact on society.

Activity: Dear student, with the help of your teacher and in cooperation with your colleagues, discuss what are the benefits of robots?

5- Benefits of robots:

Robots offer many benefits in various fields, as they help improve work efficiency, reduce errors, and save time. The most prominent benefits of robots are:

- Increased efficiency and productivity

- Industrial robots can work continuously without fatigue or interruption, which increases the amount of production in factories and saves time.
- In production lines, robots can perform repetitive tasks accurately and without any delay, which improves the quality of products and reduces errors.

- High accuracy and reduced errors

- Medical robots are used in complex surgeries, helping doctors achieve greater accuracy and reduce the chances of human error.
- In the electronics industry, robots assemble small parts with precision, improving manufacturing accuracy and reducing losses due to defects.

- Safety and security

- Robots help in dangerous tasks, such as dismantling bombs or working in hazardous environments, which reduces the risk to human lives and makes these tasks safer.
- In factories, robots can handle heavy weights and hazardous chemicals, reducing the chances of worker injury.

- Adaptability to diverse work

- Robots can be programmed to perform various tasks as needed, making them capable of performing different jobs efficiently. For example, home robots can clean or entertain.
- In the field of education, robots help students learn programming and science in interactive ways to help students and teachers.

- Reduce costs in the long run

- Although the cost of manufacturing and installing robots may be high, robots reduce costs in the long run by reducing the need for human labor, achieving greater accuracy, and reducing errors and waste.

- Contributing to development

- Robots encourage technological development and open new horizons in many fields such as space, where robots are used to explore planets.
- In the field of medicine, robots contribute to advanced medical research and the development of new treatments.

Activities:

Dear student, with the help of your teacher and in cooperation with your colleagues, you can do some of the following activities:

- Through the Internet, search for a picture of a robotic vacuum cleaner, discuss with your colleagues how it works using sensors
- Search for pictures of types of robots, try with your colleagues to classify them according to use (domestic, industrial, medical, exploratory).
- Think of a robot that helps you and your colleagues in your daily lives, describe how this robot can work.
- Draw a robot on a piece of paper for you to use at home, identifying the three parts: motors, sensors, and processor.
- Draw an idea for a robot that you wish to own or manufacture in the future, and write a short description of its function.

Learn by doing

First: Put a check mark (✓) in front of the correct sentence and a check mark (✗) in front of the incorrect sentence.

1. Sensors do not play a role in the movement of robots and sensing their surrounding environment. ()
2. Robots work is limited to factories only. ()
3. Medical robots help doctors perform surgeries. ()
4. The design of the structure affects the weight of the robot and its ability to move. ()
5. Vision sensors are used to capture sounds. ()
6. The motors used in robots include electric motors and air motors. ()
7. The control unit processes the data collected by the sensors and issues commands to the motors. ()
8. Robots rely on direct energy sources only and we cannot use batteries or solar cells. ()
9. Robots do not need to use software in their work. ()
10. Robots use communication tools to interact with users or other robots. ()
11. The areas of use of robots include industry, healthcare, and education. ()

Second: Choose the correct answer from the following:

1- The challenges facing robotics technology include.....

- A- Increased reliance on paper documents.
- B- Increased reliance on smartphones.
- C- Safety, employment and ethics.
- D- Increased reliance on traditional machines.

2- In production lines, robots can perform repetitive tasks accurately and without any delay, which leads to.....

- A- Increased efficiency and productivity.
- B- Decreased efficiency and productivity.
- C- Lack of product development.
- D- Slow production process.

3- Robots help in dangerous tasks such as.....

A- Transportation.

B- Handling heavy weights and hazardous chemicals.

C- Irrigating gardens and parks.

D- Cleaning the house

4- To take pictures and videos, we use sensors

A- Sound

B- Touch

C- Light

D- Vision

Self-assess

Go to the objectives at the beginning of the lesson.

Check the correct, I can..... box.

Lesson 4



Scratch

Lesson 4

Scratch

Objective:

By the end of the lesson, I will be able to:

- Explain the uses of the Scratch program
- Deduce the features of the Scratch program
- Use the Scratch program to create a simple project

After the lesson, check the correct box:
I can...

- | | | |
|------------------------------------|-----------------------------|---|
| <input type="checkbox"/> Very good | <input type="checkbox"/> Ok | <input type="checkbox"/> Need more work |
| <input type="checkbox"/> Very good | <input type="checkbox"/> Ok | <input type="checkbox"/> Need more work |
| <input type="checkbox"/> Very good | <input type="checkbox"/> Ok | <input type="checkbox"/> Need more work |

Engage:

What is Scratch? Suggest some simple projects where Scratch can be used.

Learn

Scratch Program:

Scratch program provides a very wide range of ideas that can be programmed, including games, animations, comics, music, simulations, and interactive games for artificial intelligence for the student to learn the principles of programming.

Scratch program allows students to be creative while learning, to feel as if they are playing a fun game while learning, as it is a fun and easy-to-use educational tool that allows learning the basics of programming in a visual and enjoyable way without the need to write a lot of complex codes.

Scratch program features:

- **Simple interface:** Scratch uses a visual interface based on blocks (bricks or commands), which are placed on top of each other in a specific system and order to form programs.
- **Educational program:** Scratch is specially designed to teach basic programming concepts in a fun and exciting way.

- **Free program:** Scratch can be downloaded from its official website and used for free.
- **Developing creative thinking:** Scratch helps learners develop their skills in creative thinking and problem-solving.
- **Enhancing problem-solving skills:** By trying mistakes and learning from them, students learn how to solve problems in a logical way.
- **Developing Collaboration Skills:** Students can work together on Scratch projects, which enhances teamwork skills.
- **An exciting start to the world of programming:** Scratch provides a strong foundation for moving on to more difficult programming languages in the future.
- **Sharing the project:** Projects can be shared with others.

Activity: With the help of your teacher and in cooperation with your classmates, discuss with them how you can start using Scratch to create your first project?

Getting Started with Scratch:

1. **Download:** Scratch can be downloaded for free from its official website, it can be obtained from the Internet through the link <https://scratch.mit.edu>.
2. **Explore:** Explore the interface and learn how the different blocks and commands work.
3. **Create a project:** Start by creating a simple project, such as animating a character or creating a short story.
4. **Save the project.**

Download the program:

Through the following website <https://scratch.mit.edu/download>, the Scratch program is downloaded.

Getting to know the program interface:

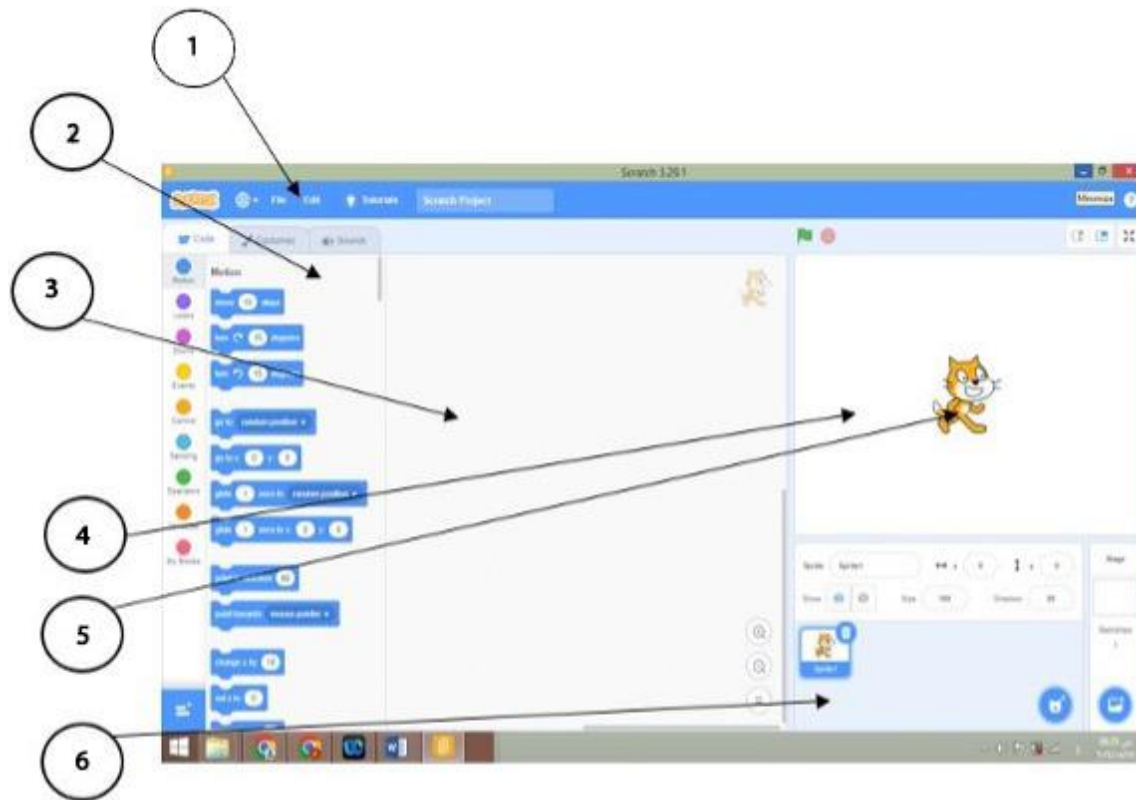

1. **Menu Bar.**
2. **Command Blocks Area.**
3. **Script Area** (it collects programming sections "composing a group of graphical commands called blocks in a specific order").
4. **Stage Area** (it shows the result of the work or project).
5. **Sprite object.**
6. **Sprites Area** (it contains the objects used in the project).

Activity:

With the help of your teacher and in cooperation with your colleagues, discuss with them how you can change the language of the program interface?

Changing the language of the program interface:

Try to change the language of the Scratch program interface to Arabic.

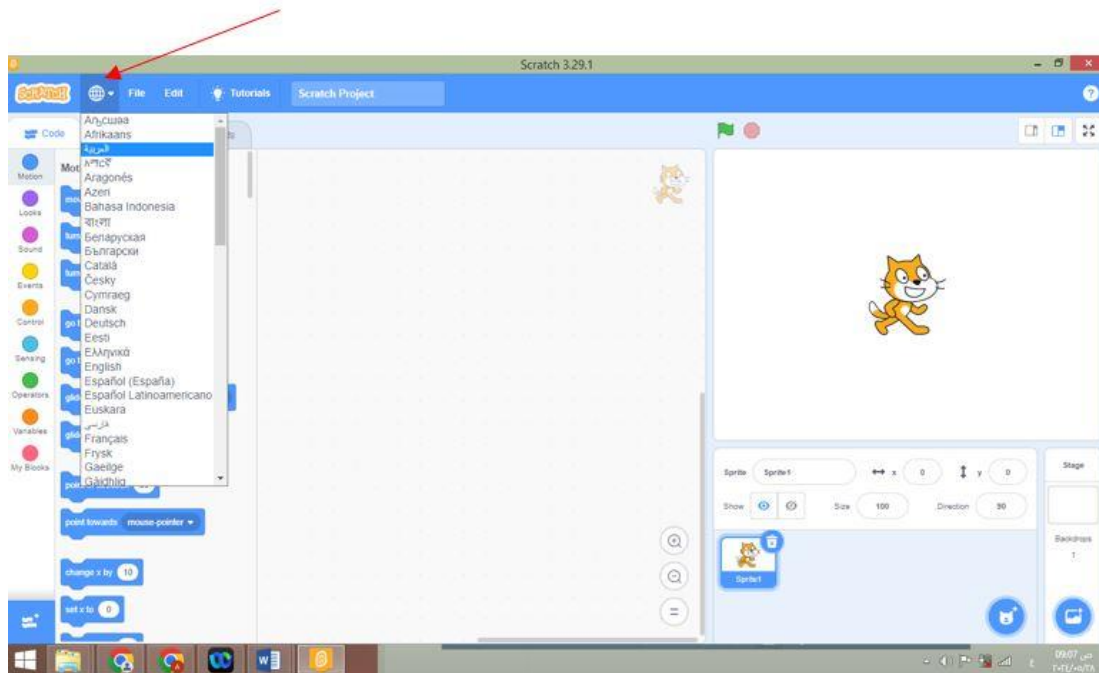

Project (1): What is required in the project is:

- Move the sprite (cat) on the platform or stage "30 steps".
- Then the phrase "Good morning" appears.

Implement the project:

To be able to move the sprite (cat) on the stage, follow these steps:

- From the **command blocks** area, **Motion** group, click and drag the command and drop it in **the programming area** Script Area as shown below:



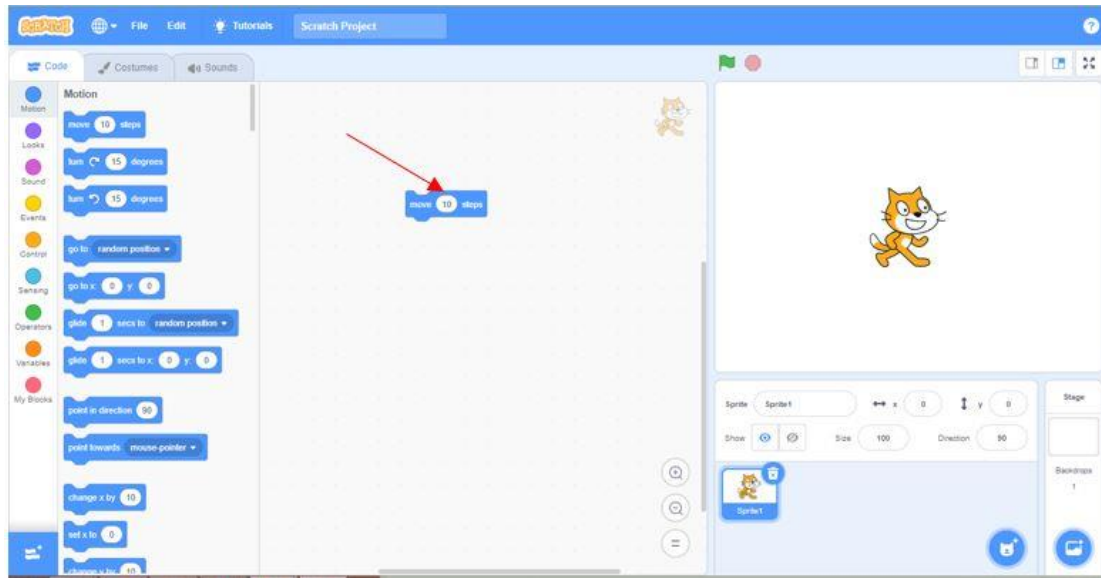

- To make the object's movement steps **30 steps**, double-click on the value 10 on the (**command**) block and write the value 30 as in the following figure:

Write the value 30 on the block as in the following figure:

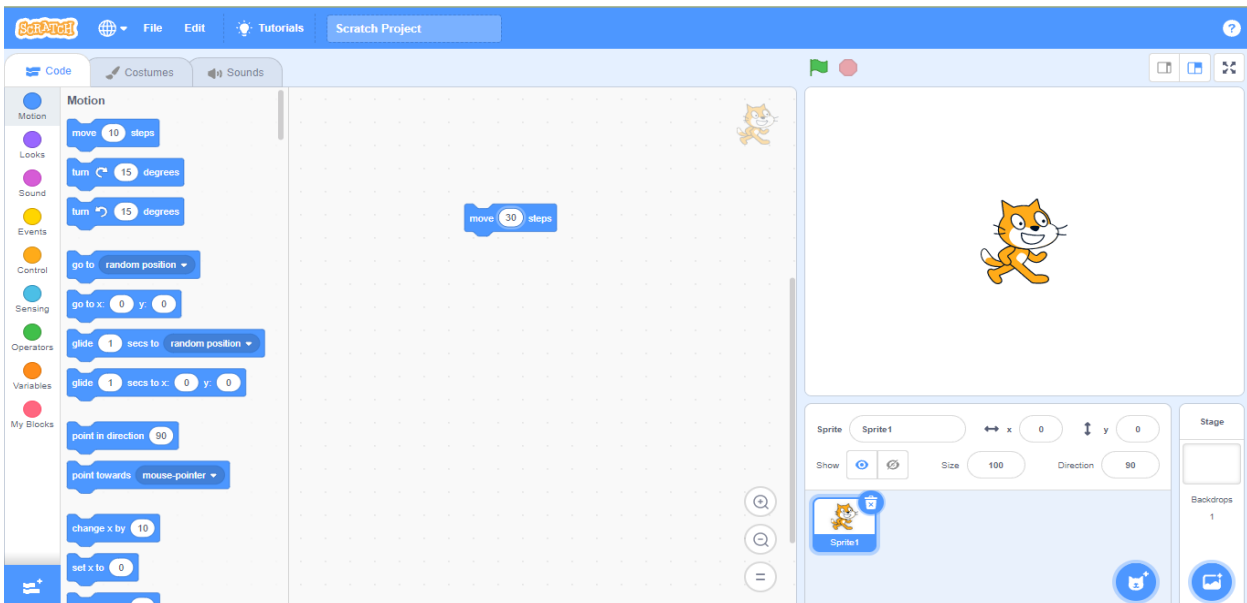

To display the phrase "Hello":

1-Select the **Looks** command

2-Then **select the command**



group

3-Then **click and drag on the command** and drop it into the platform below the previous command.

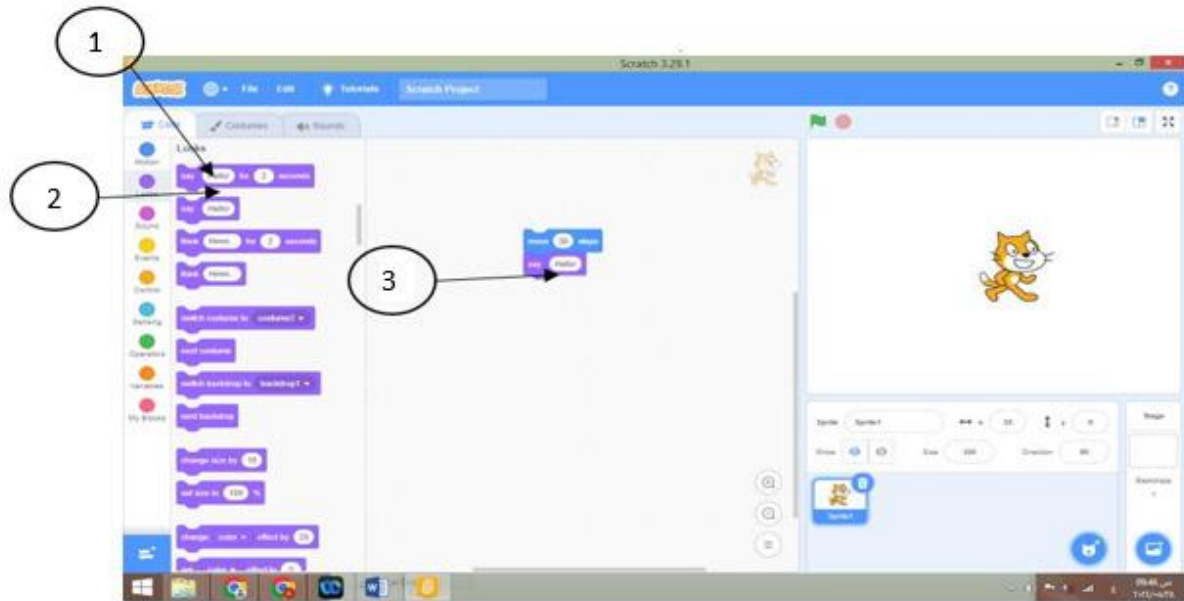

To view the implementation of the project steps

1- In the Script Area, click on **Events Blocks**

2- Click on the command  and drag it to the platform

3- To be installed at the beginning of the programming section as shown in the figure

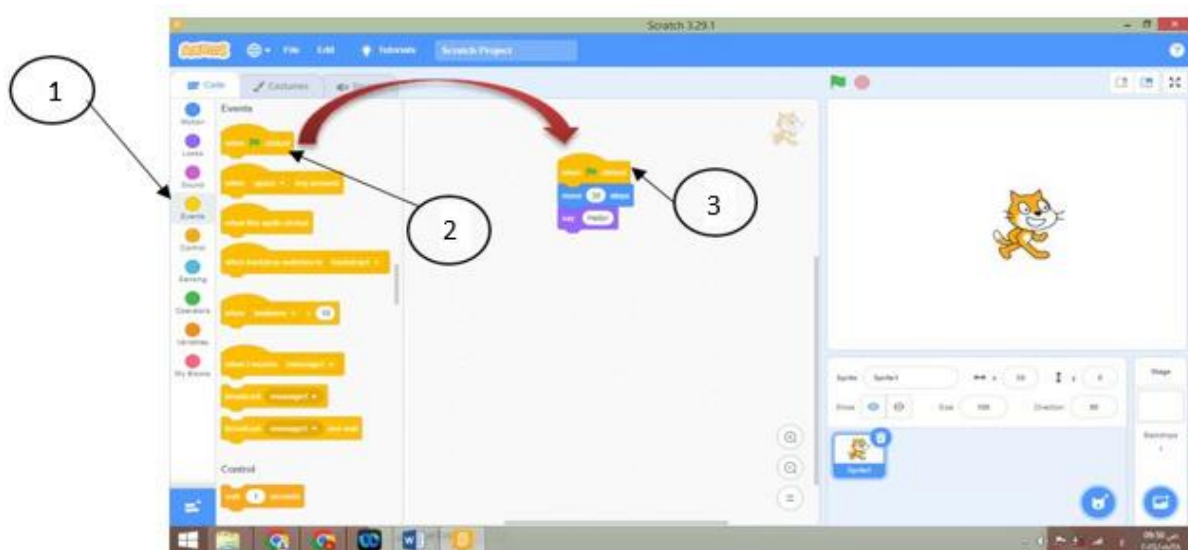

4-To execute the project, click on the icon



5-To stop the execution of the project, click on the icon 



Note: When executing the previous project, we notice that the movement was done quickly. To address this, we can use the Wait command from Control Blocks by following the following:

1- Click on Control Blocks

2- Click and drag a command  and drop it into **the Script Area**

3- Place it as shown below:

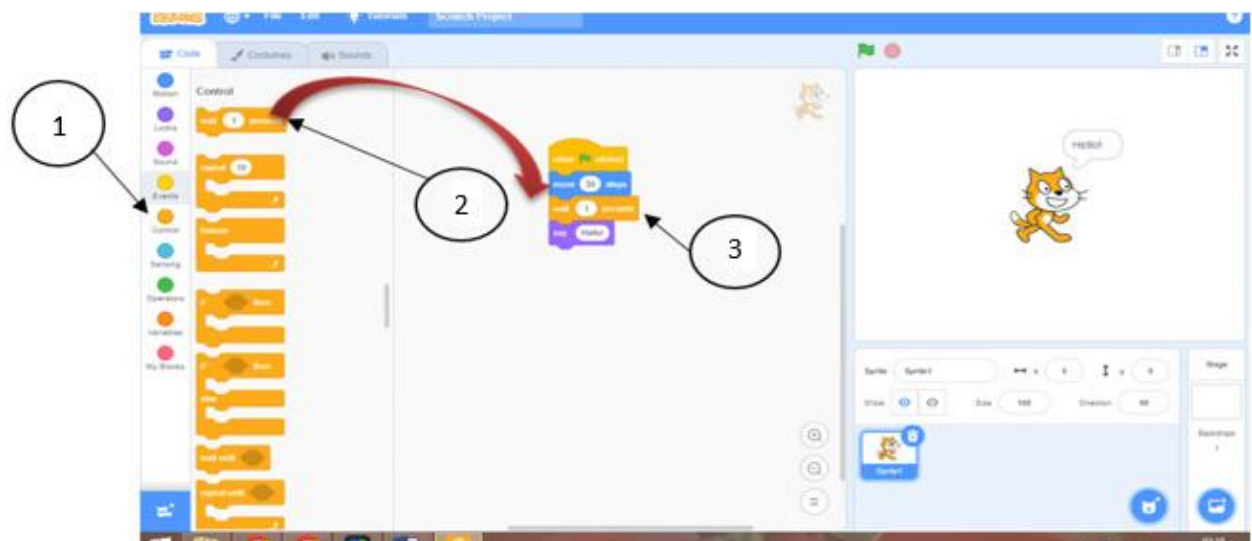

4-To re-execute the project, click on the icon 

Important notes:

- The wait value represents (1 second).
- Installing a set of commands in a specific order called a **code section**.
- Use click, drag and drop to deal with any command (within) the code section.

Modify the project (1): Modify the previous project to make the movement continuous

- To make the movement continuous, you can install the command several times
- Re-arrange it by clicking and dragging to the place where you want to start the repetition
- Modify the word "Hello" to the phrase "Good morning".

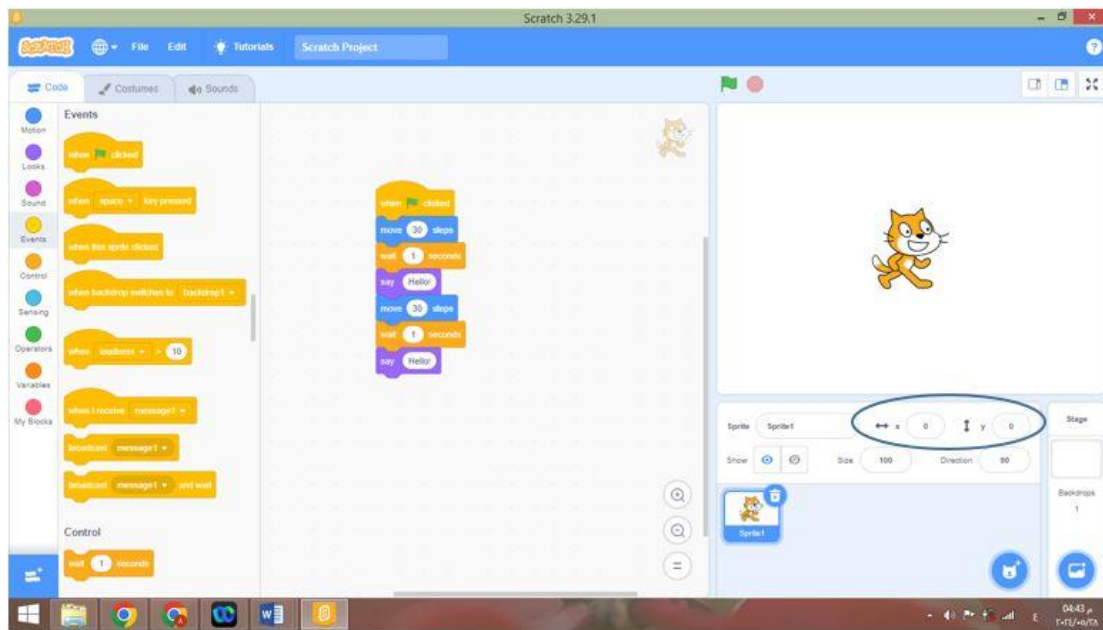

Activity:

With the help of your teacher and in cooperation with your colleagues, discuss with them how you can:

- Determine the value of the object's coordinates on the platform?
- Change the value of the object's coordinates on the platform?

Note that:

Before implementing the project, the value of the object's coordinates on the platform is:

$X=0$ which is the horizontal axis and represents horizontal movement, $Y=0$ which is the vertical axis and represents vertical movement

Implement the project Note the value $X=0$ and the value $Y=0$ after implementing the project

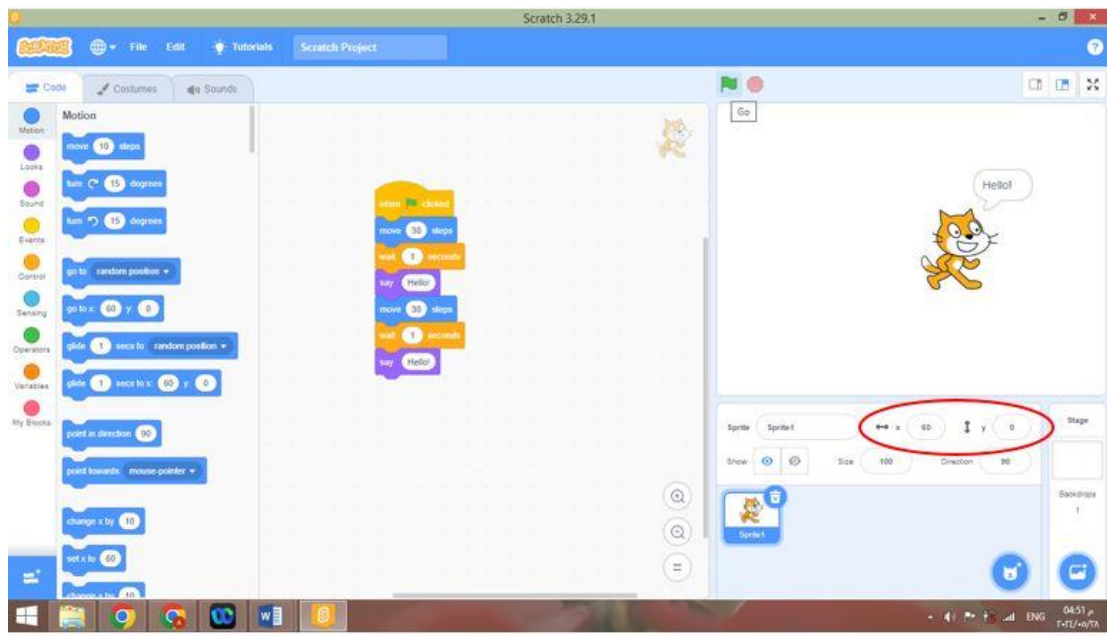

- **You can** control the position of the Sprite on the platform by clicking on it and (drag & drop).

Activity:

With the help of your teacher and in cooperation with your colleagues, discover with them the coordinates of the platform, how can you change the position of the object on the platform?

Discover the coordinates of the platform

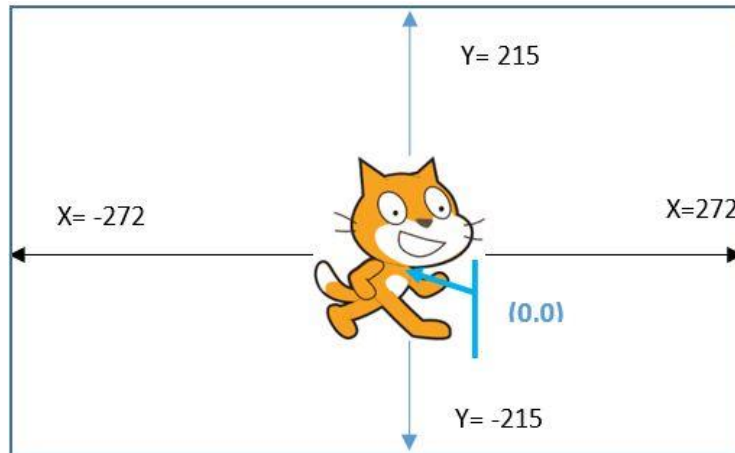

- **You can** control the location of the Sprite object on the platform by clicking on it and (drag & drop) to another place on the platform.

Save the project in a file

To save your project, do the following:

- 1- From the File menu, choose Save to your computer.
- 2- Select a location to save the file on one of the storage media.
- 3- Type the file name "Project 1"

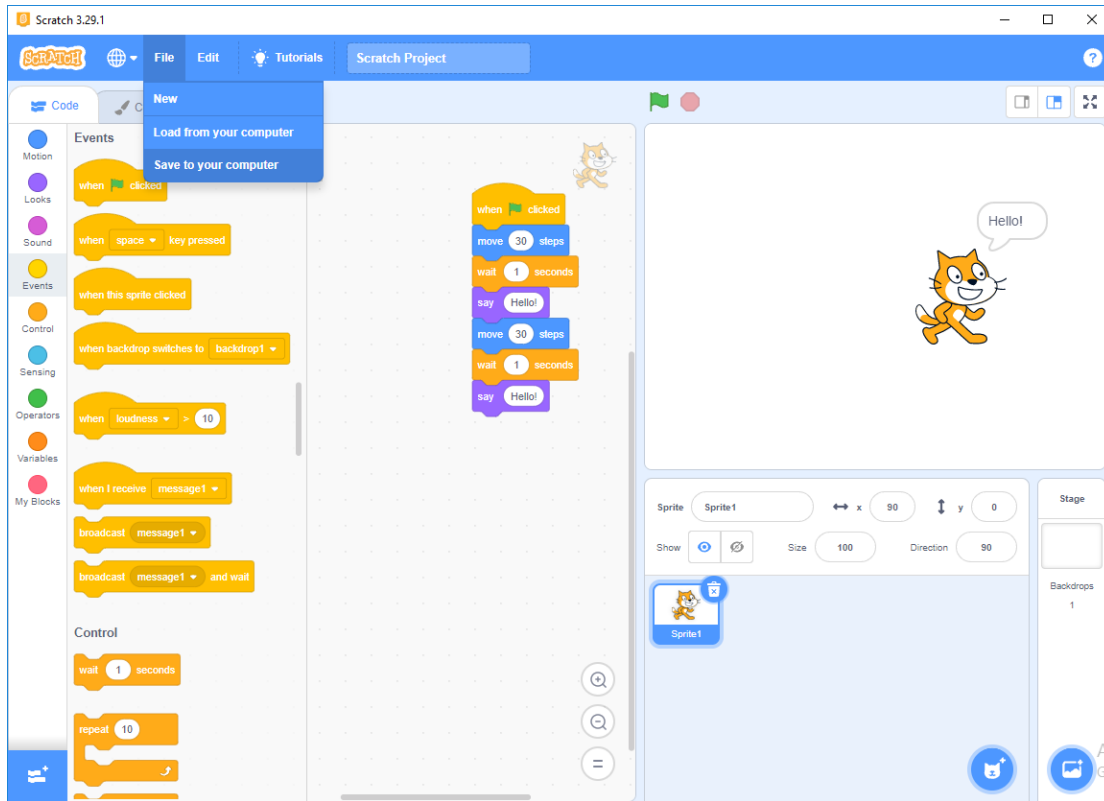

Note that:

- The file name is "Sb3 Project 1"
- The file extension is Sb3.

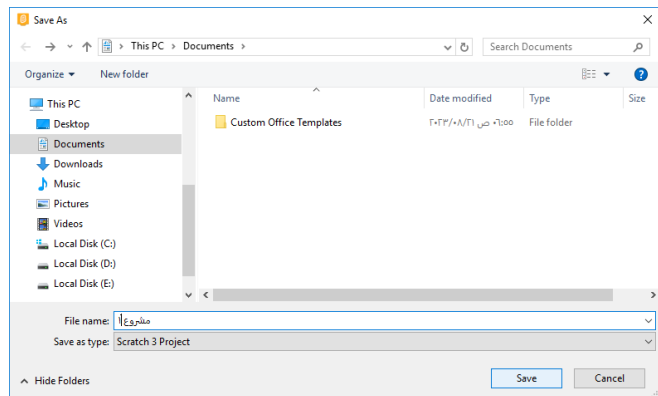

Learn by doing

Put a check mark (✓) in front of the correct sentence and a check mark (✗) in front of the incorrect sentence.

- 1- The Scratch program provides a very wide range of ideas that can be programmed. ()
- 2- The Scratch program helps the student learn the principles of programming.()
- 3- The Scratch program is considered a difficult educational tool to use. ()
- 4- The student in the Scratch program needs to write a lot of complex codes. ()
- 5- Scratch uses a visual interface based on blocks. ()
- 6- The Scratch program is paid. ()
- 7- In the Scratch program, students face difficulty in sharing projects with others. ()
- 8- In the Scratch program, the Stage area shows the programming sections. ()
- 9- In the Scratch program, the result of the work or project appears in the Area Blocks area. ()
- 10- To implement the project, click on the symbol. ()

Self-assess

Go to the objectives at the beginning of the lesson.

Check the correct, I can..... box.

Lesson 5



**Sprites Area
in
Scratch**

Lesson 5

Sprites Area in Scratch

Objectives:

By the end of the lesson, I will be able to:

- Discuss the concept of sprites area in Scratch
- Create a simple project in Scratch and its role in our lives.
- Develop my project (add-delete-modify) for sprites on the project

After the lesson, check the correct box: I can...

<input type="checkbox"/> Very good	<input type="checkbox"/> Ok	<input type="checkbox"/> Need more work
<input type="checkbox"/> Very good	<input type="checkbox"/> Ok	<input type="checkbox"/> Need more work
<input type="checkbox"/> Very good	<input type="checkbox"/> Ok	<input type="checkbox"/> Need more work

Engage:

How can you set up a simple project on Scratch?

Learn

Sprites area (contains the sprites used in the project), sprites used in the project appear as follows:

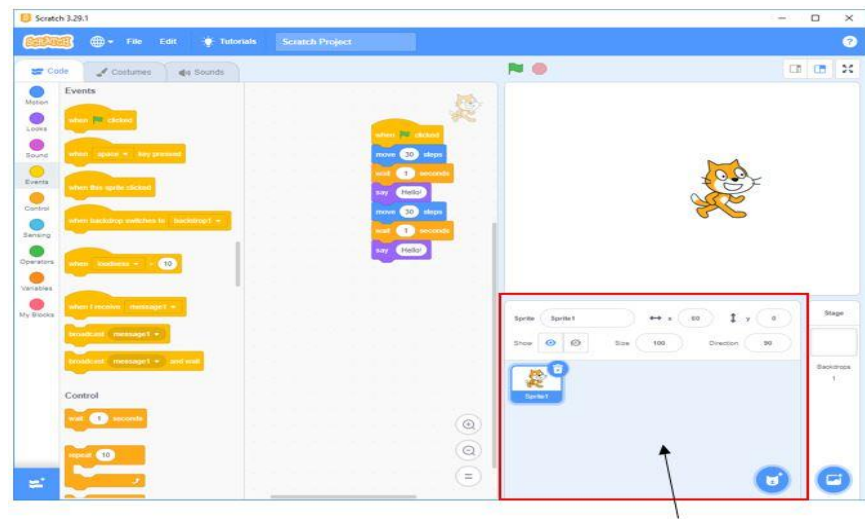

- 1- The name of the sprite (you can modify it by clicking on it and renaming it).
- 2- The location of the sprite and determines it (the horizontal axis is the X values and the vertical axis is the Y values, note the current location of the sprite (cat) on the platform is ((60,0)
- 3- The direction of the sprite's movement: (You can change the direction by **changing the Direction value**).
- 4- Show or hide the sprite on the platform.
- 5- The size of the sprite and its value can be changed.
- 6- Delete the sprite from the platform.
- 7- Add a new sprite Choose Sprite.

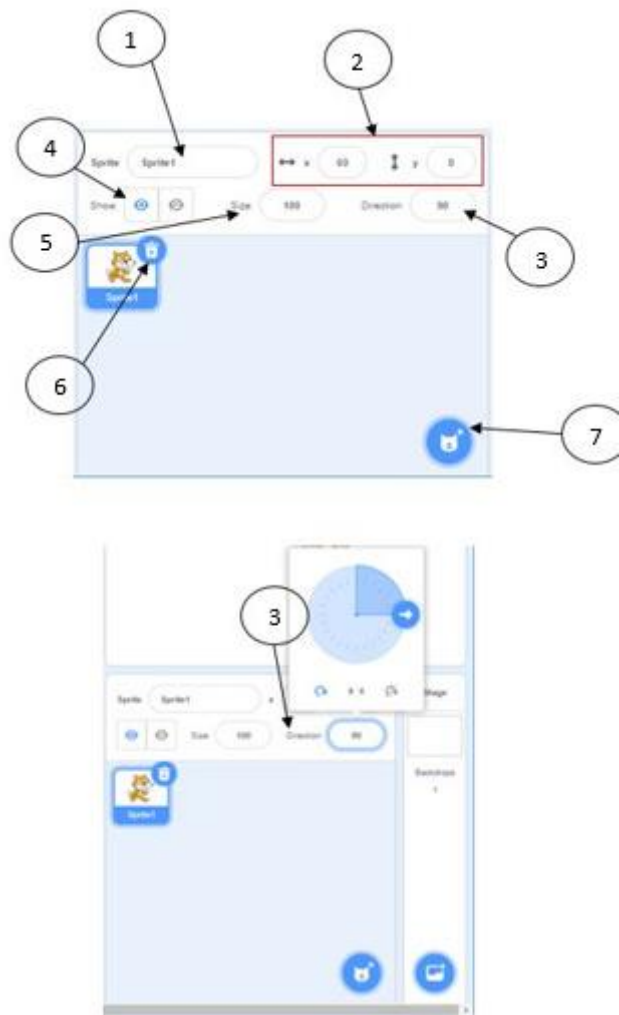

Activity:

With the help of your teacher, make the following changes to the Sprite:

- 1- The name of the sprite (you can modify it).
- 2- The location of the sprite on the platform is (100,80)
- 3- The direction of the sprite's movement.
- 4- Show or hide the sprite from the platform.
- 5- The size of the sprite to the value 50.
- 6- Delete the sprite from the platform.
- 7- Add a new sprite.

Add a new sprite:

To add a new sprite in the sprites area

-Click on Choose Sprite

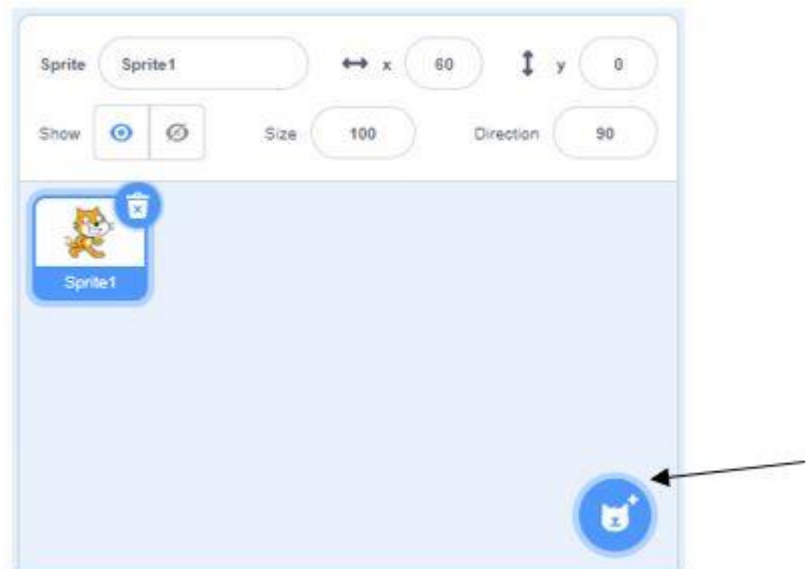

Select Basketball

-Remove the cat sprite from the stage

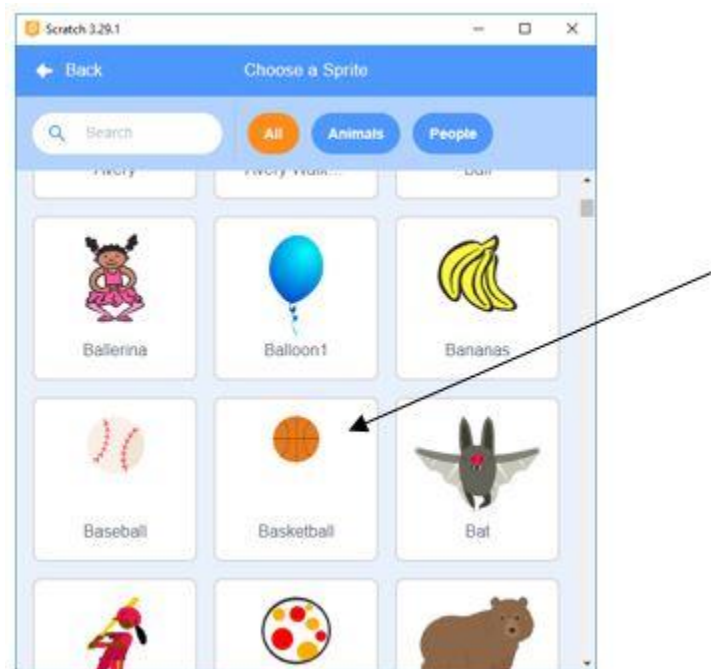

Project 2:

Required to move the ball randomly on the platform while making a sound for the ball and repeating this 10 times

Project creation steps:

1-From Motion

2-Choose the Go to random position command

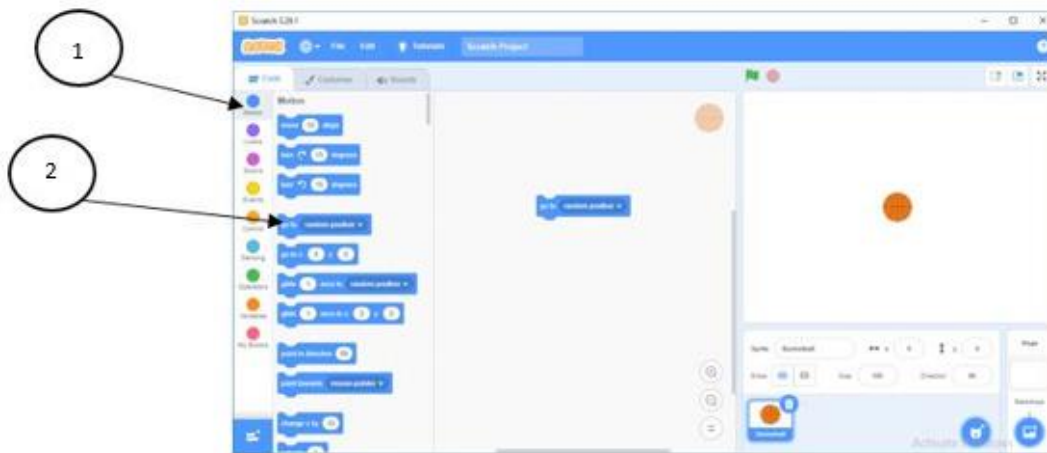

3-From Sound

4-Choose the command Play sound

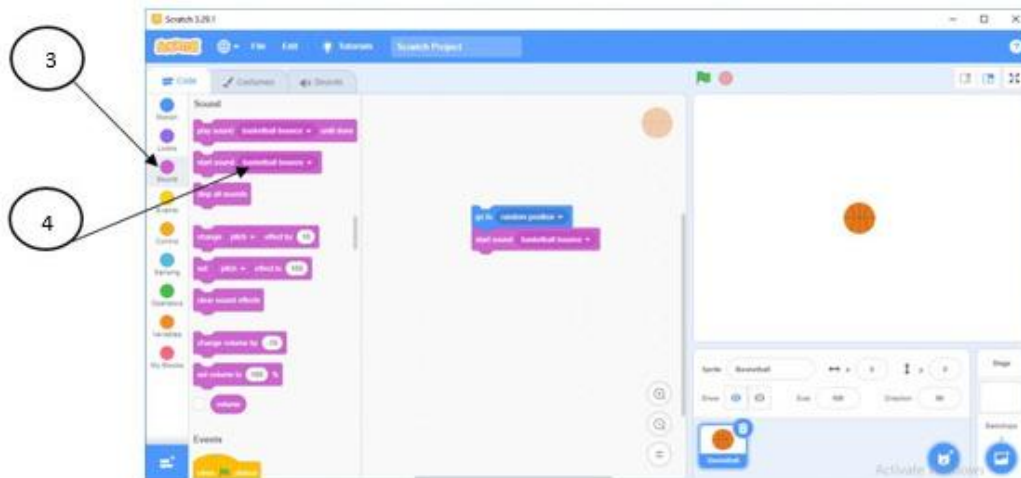

- 5-To repeat the movement 10 times from Control
- 6-Choose the Repeat command.

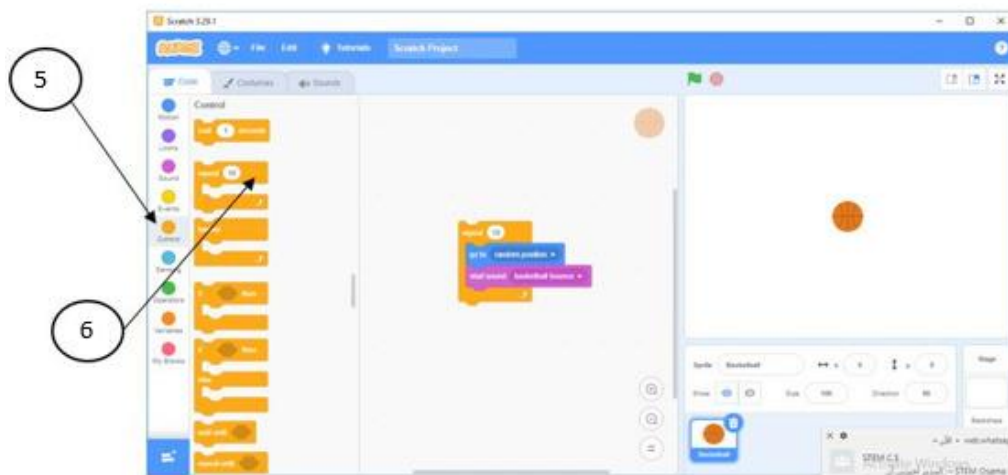

To execute the project

7-From Events

8-Choose the When Clicked command

Test the execution of the project

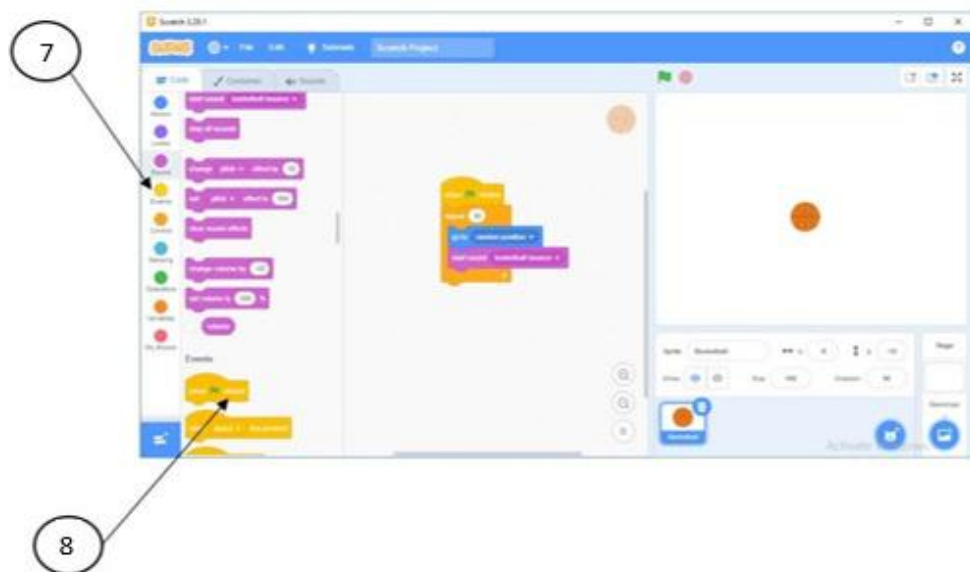

Project (3) Spaceship

-Insert a new sprite Rocketship

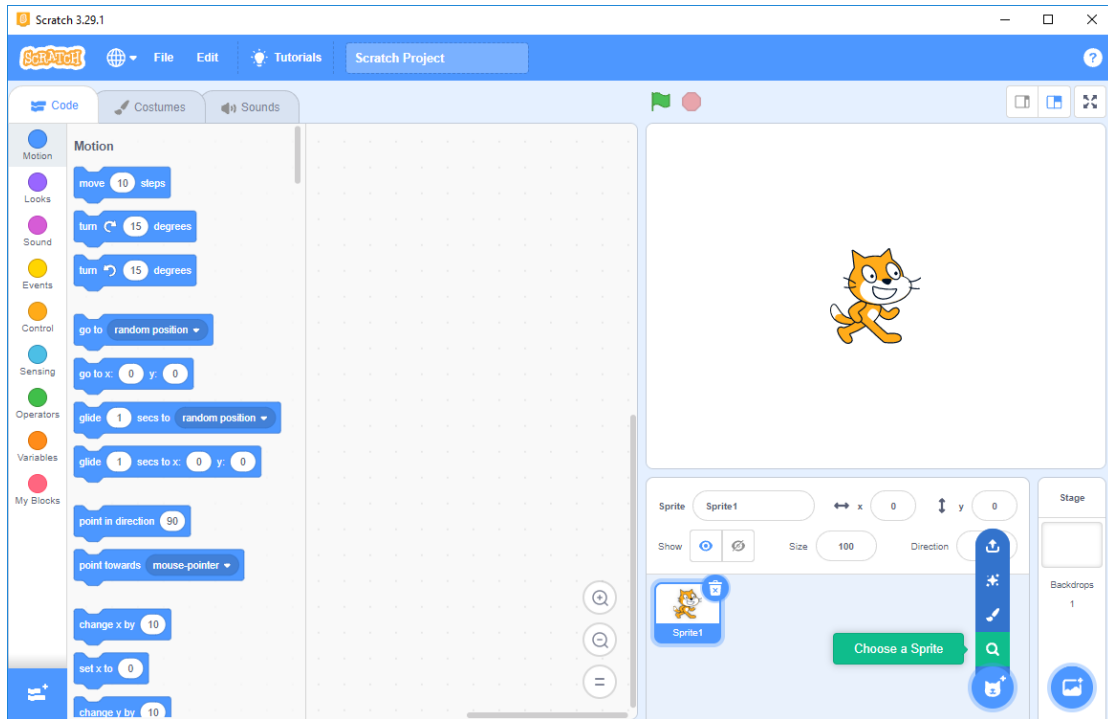

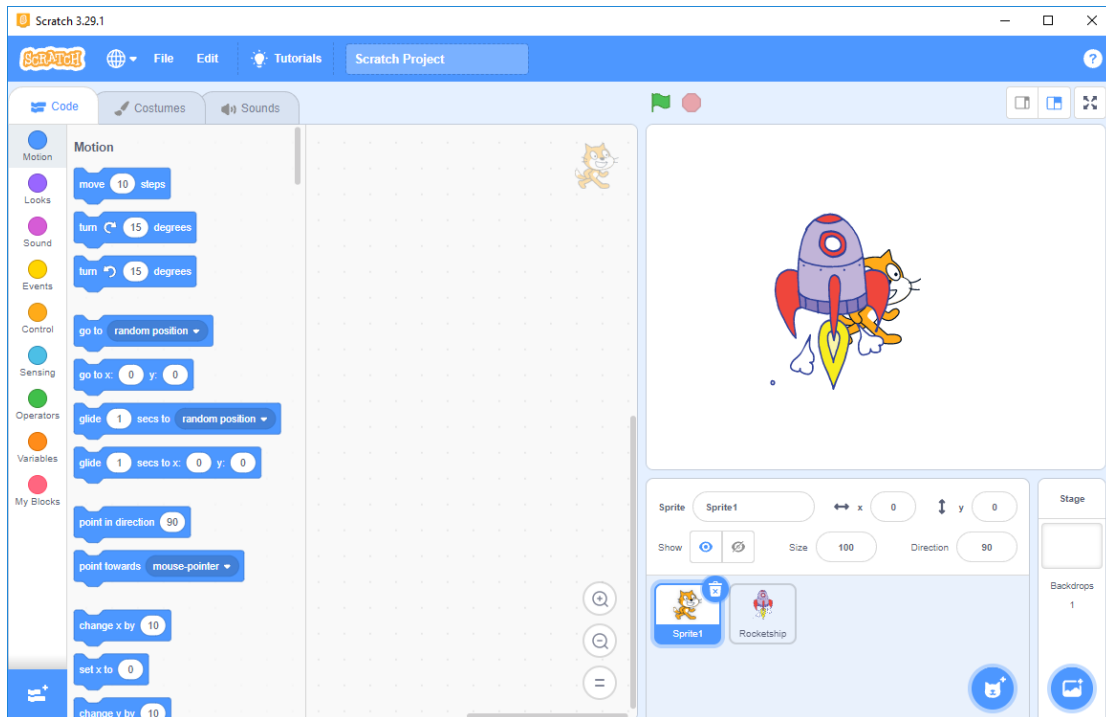
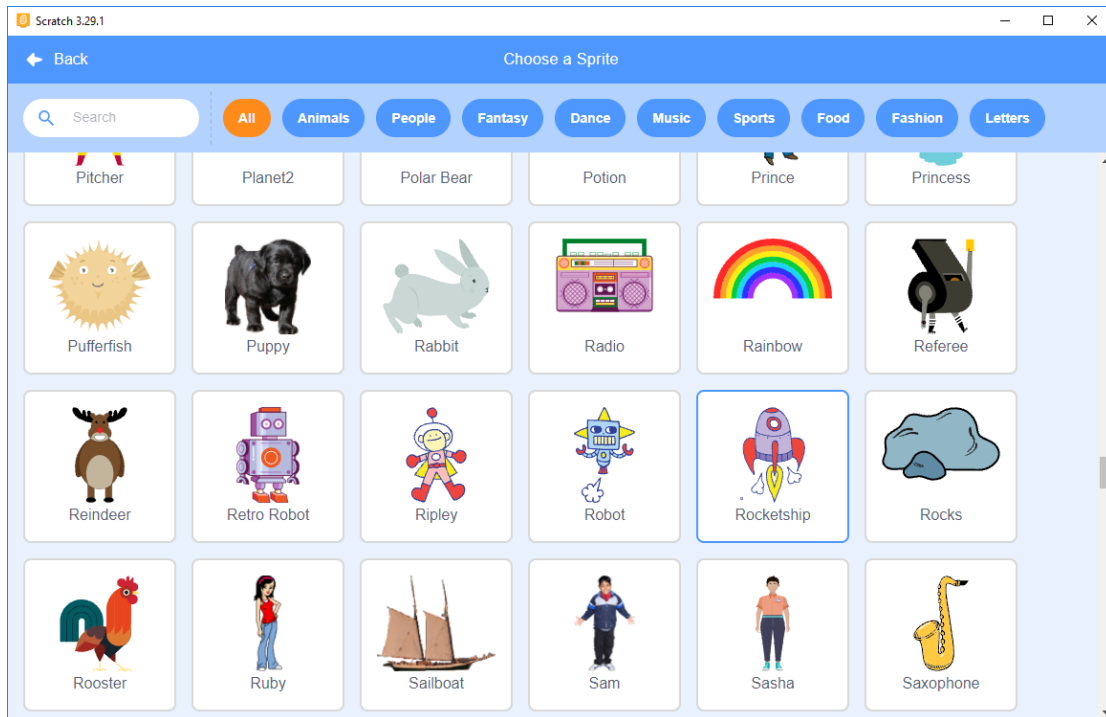

-Remove the cat sprite from the stage.

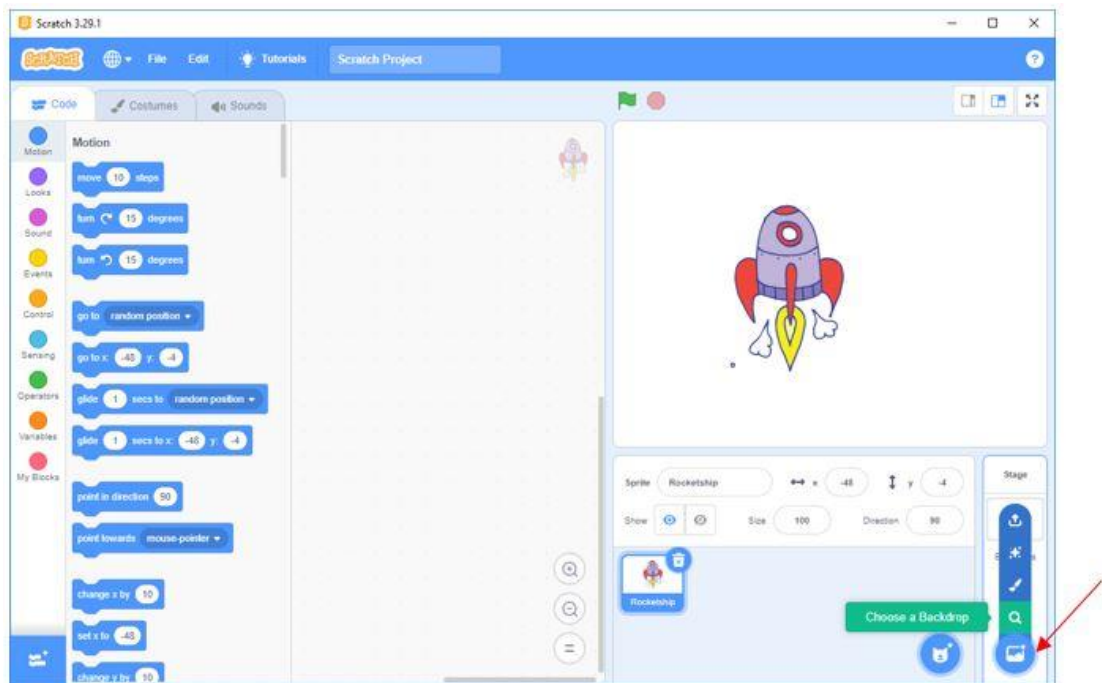
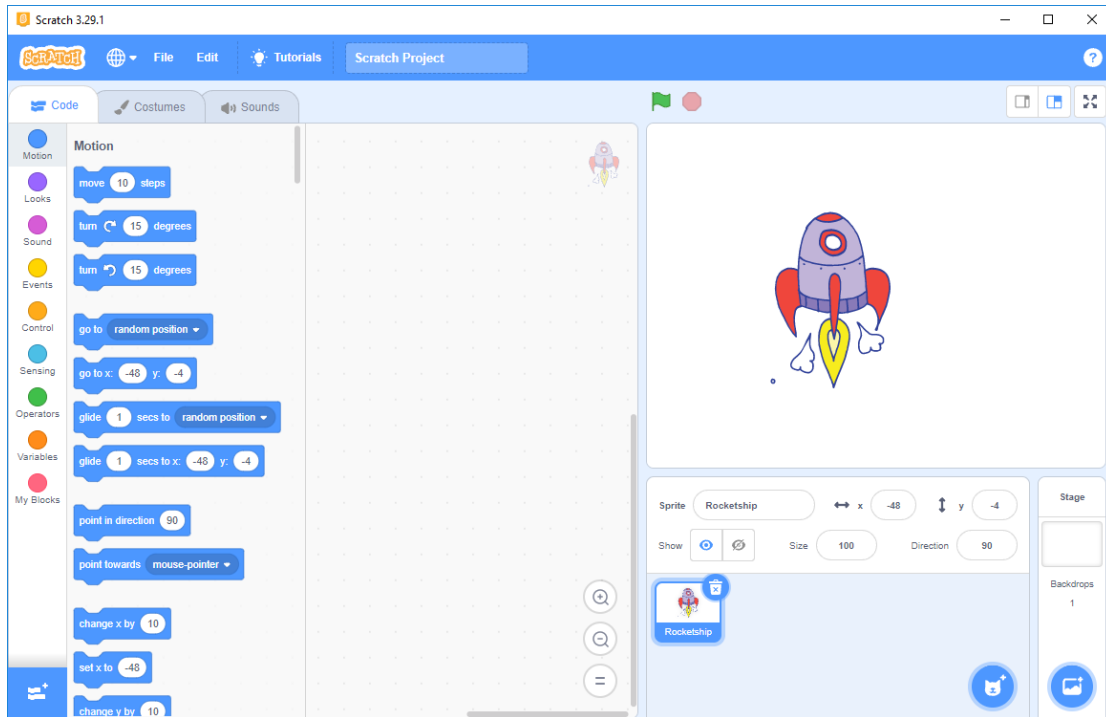

-Insert a new background by clicking on Choose a Backdrop, browse through the different backgrounds and then choose “Space”.

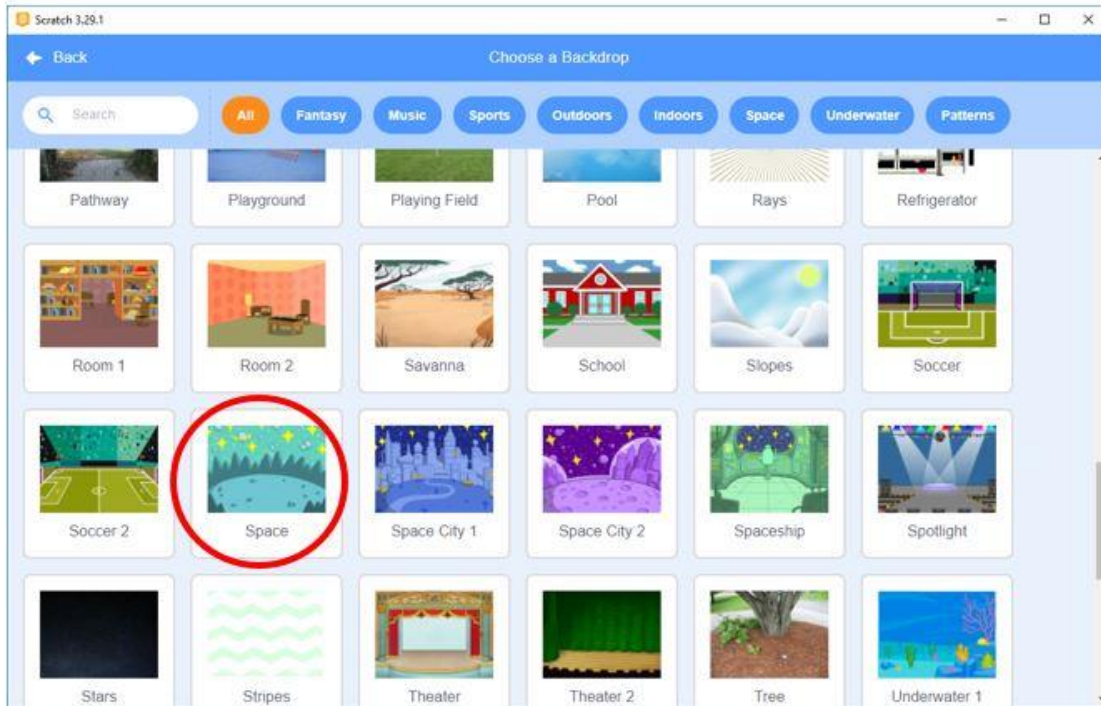

Activity:

With the help of your teacher and in cooperation with your colleagues, do the following:

Make the spaceship move randomly, make a sound for the spaceship, change the size of the spaceship, repeat this 5 times, make the spaceship's location on the platform start from (0, 0)

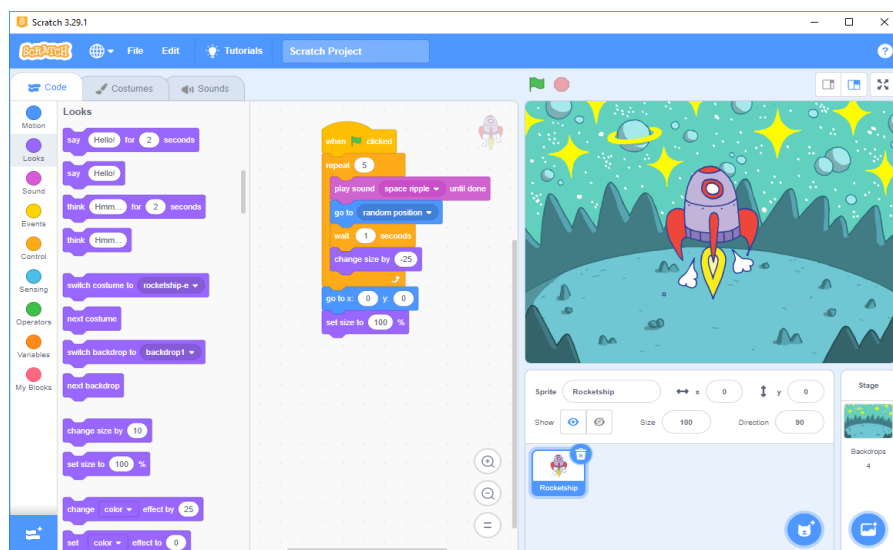

Implement Project 3

Activities and Projects:

With the help of your teacher and in cooperation with your classmates, do the following:

Square Drawing Project:

1. **Open a new project:** Open Scratch and start a new project.
2. **Select the pen:** We will use the "pen" to draw our picture. In the code area, find the "pen" section and drag the "pen" block down. This block will make the pen start drawing.

Note: Click on Add

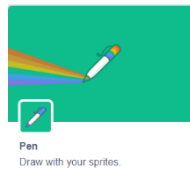

Extension and the pen

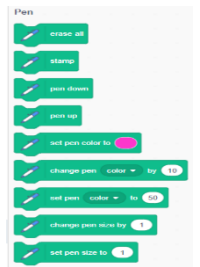

Blocks will appear as shown in the opposite figure:

3. **Setting Color and Size:** Before you start drawing, you can set the line color and size using the blocks in the "Pen" section. For example, you can use the "Set Pen Color to" block to choose a specific color, and the "Set Pen Size to" block to set the line thickness.
4. **Moving the Pen:** Now, we will move the pen to draw the shape we want. Use the "Go to x:y:" block to set the starting point, and then use the "Go to x:y:" block again to set the ending point. This will make the pen draw a straight line between the two points.
5. **Repeating Steps:** Repeat the previous steps to draw more lines and form the shape you want.

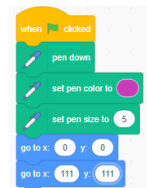

Notes:

- **Drawing different shapes:** You can draw any geometric shape by setting the start and end points of the lines appropriately.
- **Adding details:** You can add details to your image such as eyes, mouth, and ears.

Project: Drawing a circle

To draw a circle, you can use the "Repeat" block to repeat the process of drawing short lines at different angles, this helps with the circle drawing effect.

Learn by doing

Put a check mark (✓) in front of the correct sentence and a check mark (✗) in front of the incorrect sentence.

1. The sprites used in the project appear in the Sprites area. ()
2. The sprite name can be modified only once. ()
3. The location of the sprite on the platform is determined by the value of the horizontal axis X only. ()
4. The horizontal and vertical axis are used to know the current location of the sprite on the platform. ()
5. To modify the name of the sprite, click on its current name and rename it. ()
6. The direction of the sprite's movement can be changed by clicking on the word Direction. ()
7. The sprite can be shown or hidden on the platform by clicking on Choose Sprite. ()
8. The size of the sprite is changed by its value in the Sprites area. ()
9. The sprite can be deleted from the platform. ()
10. Only one sprite can be added to the platform. ()
11. To add a new sprite, click on Choose Sprite. ()
12. The Stop command is used to watch the project execution. ()
13. A new background is inserted for the project through the programming area. ()
14. The Start command is used to stop the project. ()
15. We use the coordinates (x, y) to locate the point on the stage. ()

Self-assess

Go to the objectives at the beginning of the lesson.

Check the correct, I can..... box.

Lesson 6



**Principles of
Python**

Lesson 6

Principles of Python

Objectives:

By the end of the lesson, I will be able to:

- Explain the concept of the Python programming language
- List the uses of the Python language
- Practice the steps to download the Python language to my device

After the lesson, check the correct box: I can...

- | | | |
|------------------------------------|-----------------------------|---|
| <input type="checkbox"/> Very good | <input type="checkbox"/> Ok | <input type="checkbox"/> Need more work |
| <input type="checkbox"/> Very good | <input type="checkbox"/> Ok | <input type="checkbox"/> Need more work |
| <input type="checkbox"/> Very good | <input type="checkbox"/> Ok | <input type="checkbox"/> Need more work |

Engage:

What is Python programming language? How can the application be downloaded from the official website?

Learn

What is Python:

Before we start defining Python, we must know that the first version of the language was in 1991. It is a programming language widely used in data science and machine learning, and for developing websites and applications.

Features of Python:

1. **Open source:** Python is free and open source, allowing everyone to use and develop it.
2. **Interpreted language:** Which means that it **translates programming codes** line by line, so if there are errors in the program code, it will stop working, as programmers can quickly find errors in the codes.
3. **Versatility:** It can be used in developing web applications, data science, artificial intelligence, machine learning, and game programming.

4. **Easy-to-use language:** It is one of the easiest programming languages for beginners because of its simple and organized formula and uses words similar to English, unlike other programming languages.
5. **Integration:** Python can be integrated with other languages such as C, C++, and Java, and it can also be used in developing multi-platform programs.
6. **Libraries:** Python has many libraries that you can use.

Python Libraries

They are pre-built codes and functions that help programmers perform specific tasks without having to write codes from scratch, libraries are a powerful tool that increases the efficiency and effectiveness of programming using Python, as they provide ready-made solutions to many common problems or requirements.

like:

NumPy: is a library widely used in data science, statistics, and artificial intelligence.

Pandas: is a library for analyzing and processing data.

Matplotlib: is a library for creating graphs and charts

How to download the program from the official website:

1- Visit the official Python website www.python.org

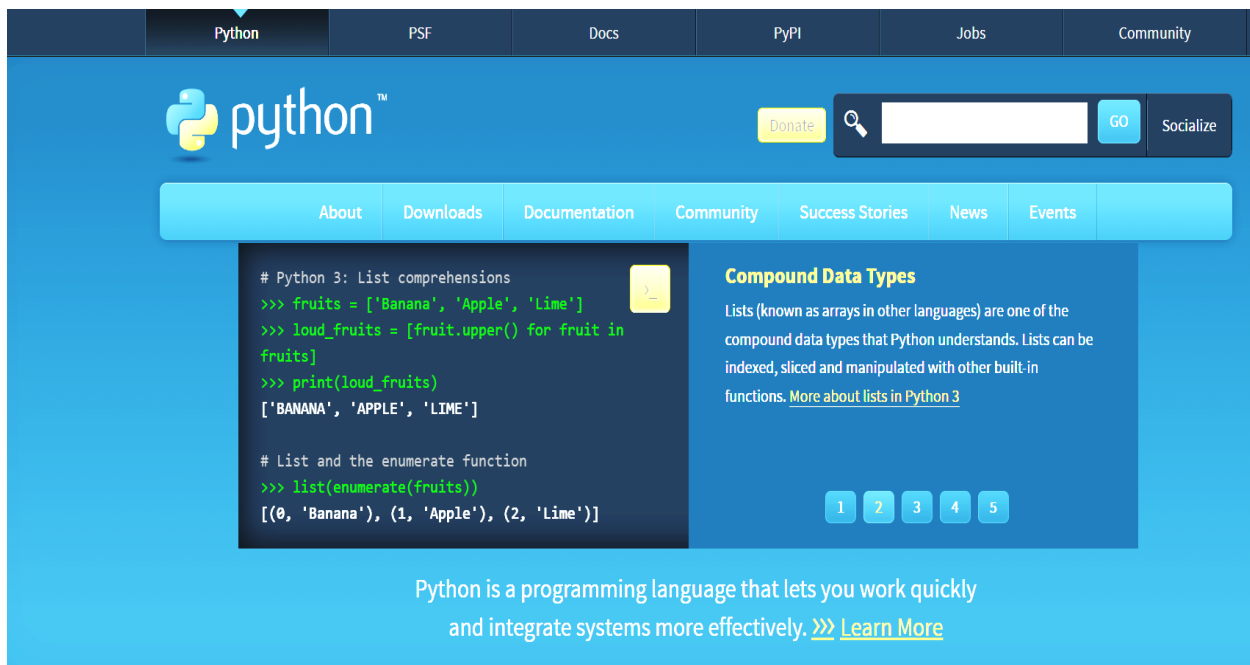

The screenshot shows the Python.org homepage. At the top, there is a navigation bar with links for Python, PSF, Docs, PyPI, Jobs, and Community. Below this is the Python logo and a search bar. A secondary navigation bar contains links for About, Downloads, Documentation, Community, Success Stories, News, and Events. The 'Downloads' link is highlighted with a red arrow. The main content area features a code snippet demonstrating list comprehensions and the enumerate function, followed by a section titled 'Compound Data Types' explaining lists. At the bottom, a tagline reads: 'Python is a programming language that lets you work quickly and integrate systems more effectively. >>> [Learn More](#)'

2- Choose “Download”

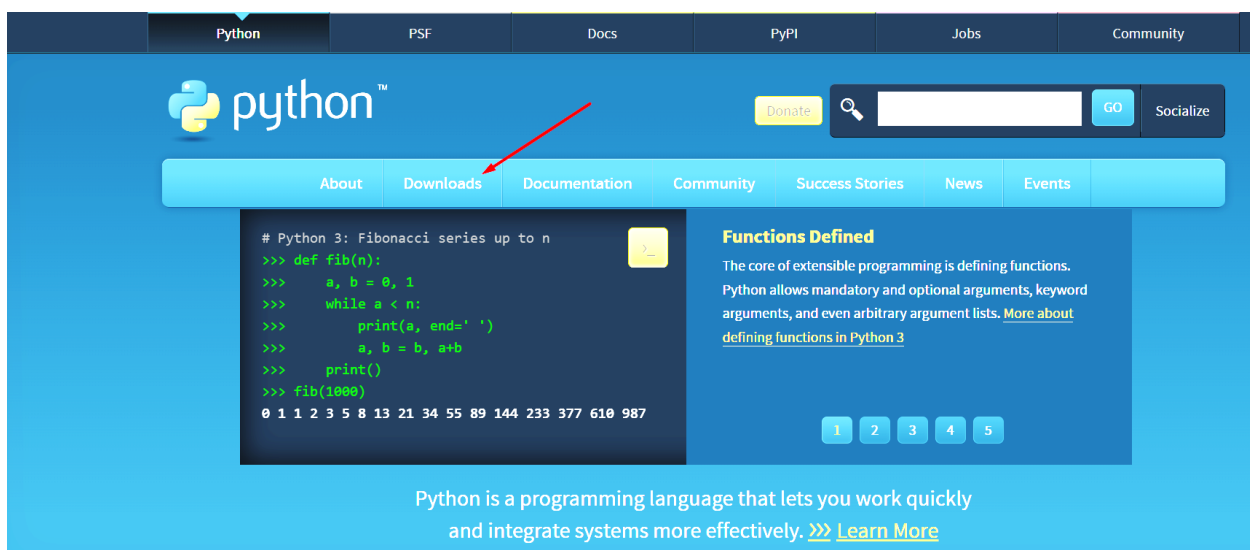

This screenshot is identical to the one above, showing the Python.org homepage. The 'Downloads' link in the secondary navigation bar is highlighted with a red arrow, indicating the next step in the process.

3- Then choose the system you are working on (Windows, Mac, or Linux).

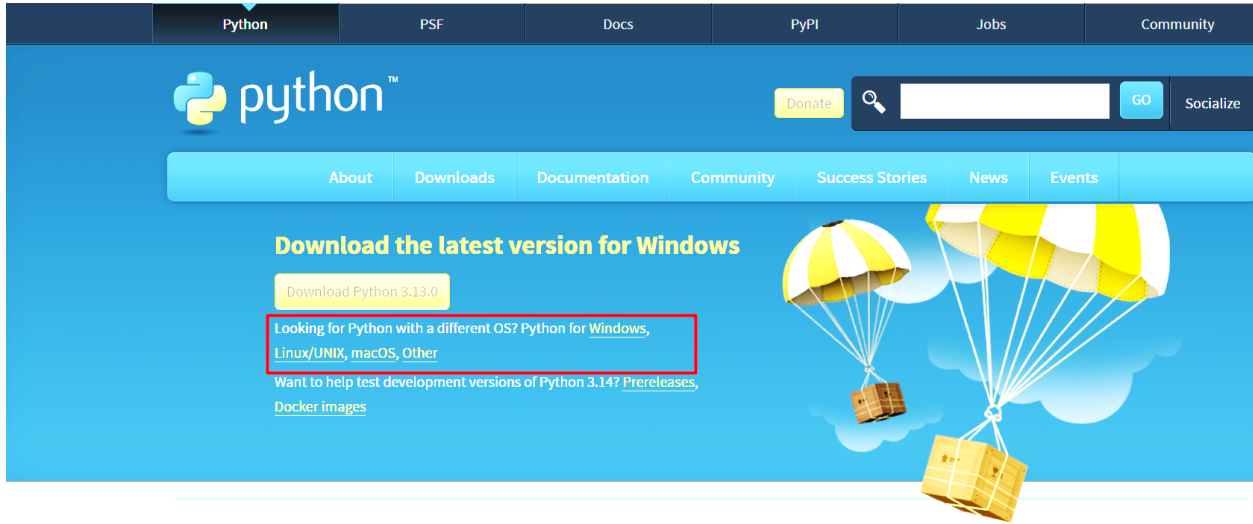

4- You must choose 64 bit or 32 bit, according to your device specifications.

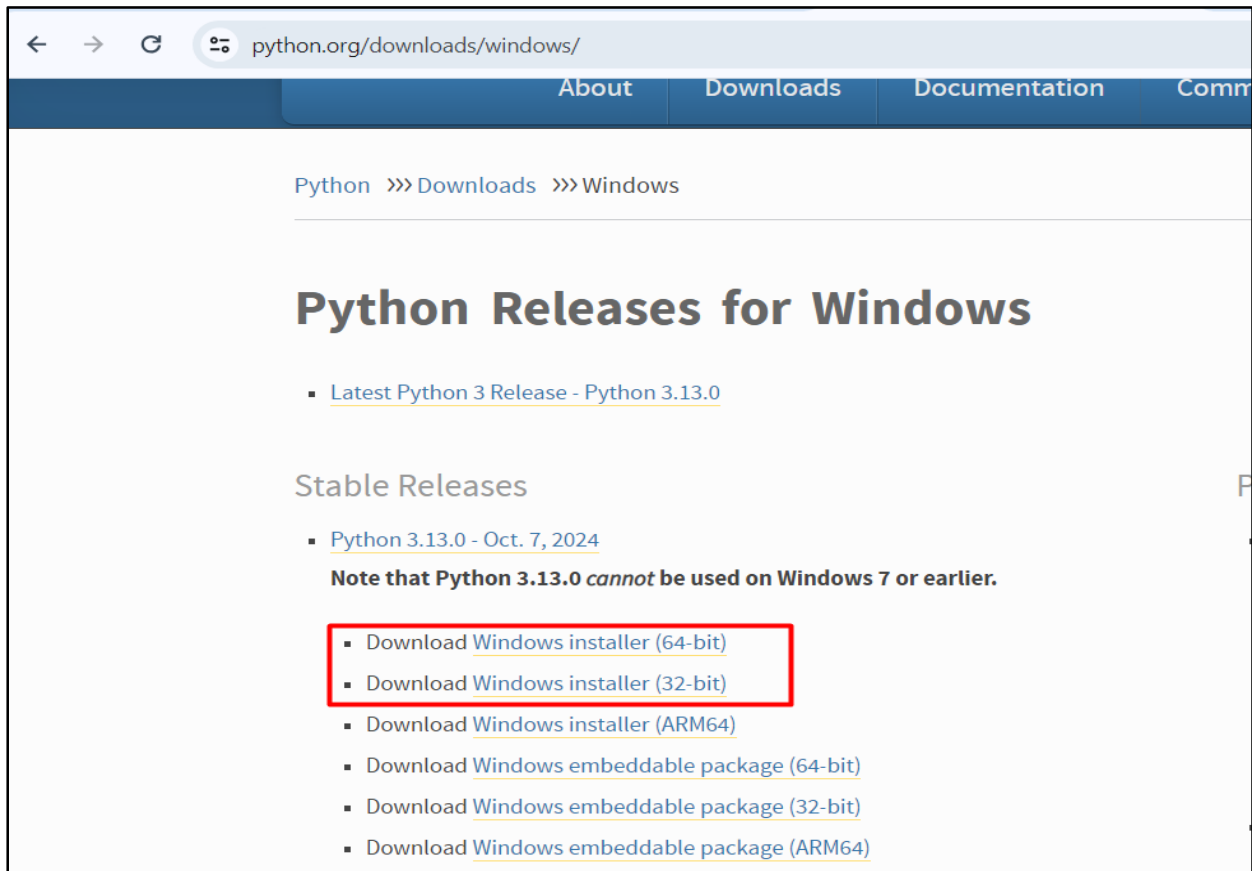

5- After downloading, install the program on your device and follow the instructions.

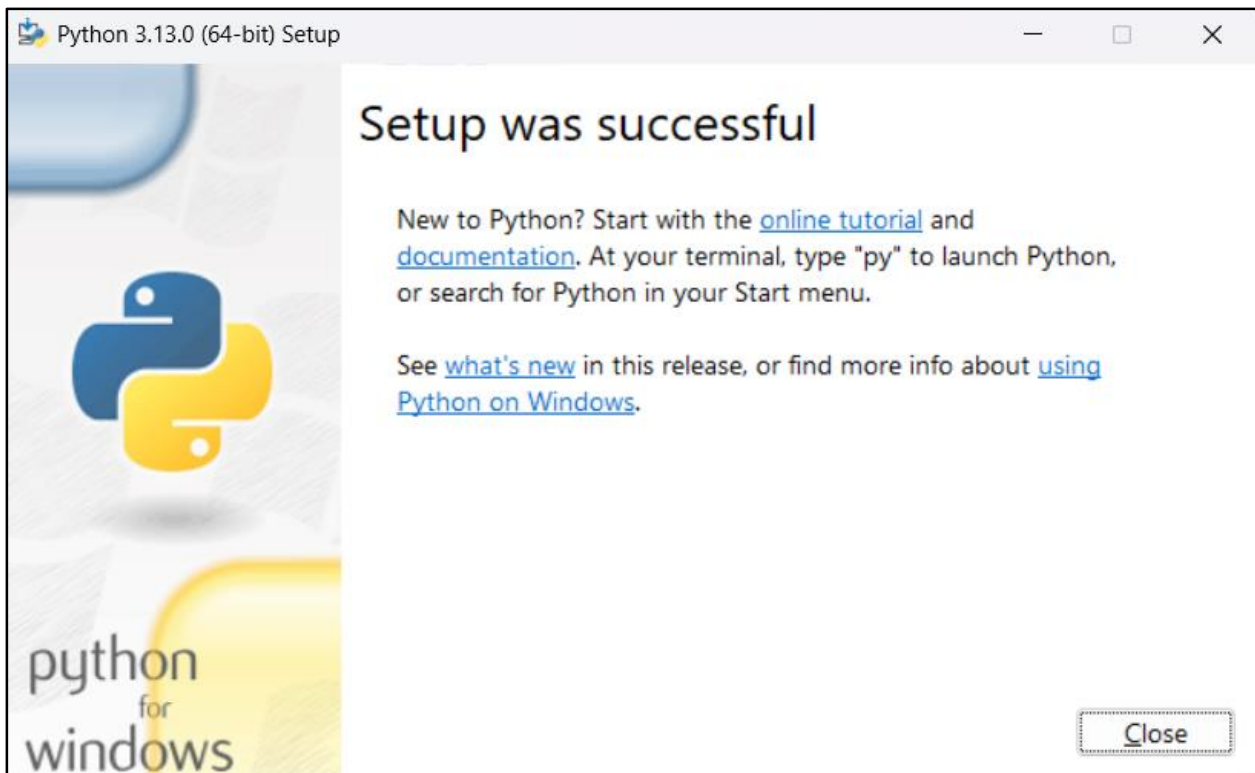
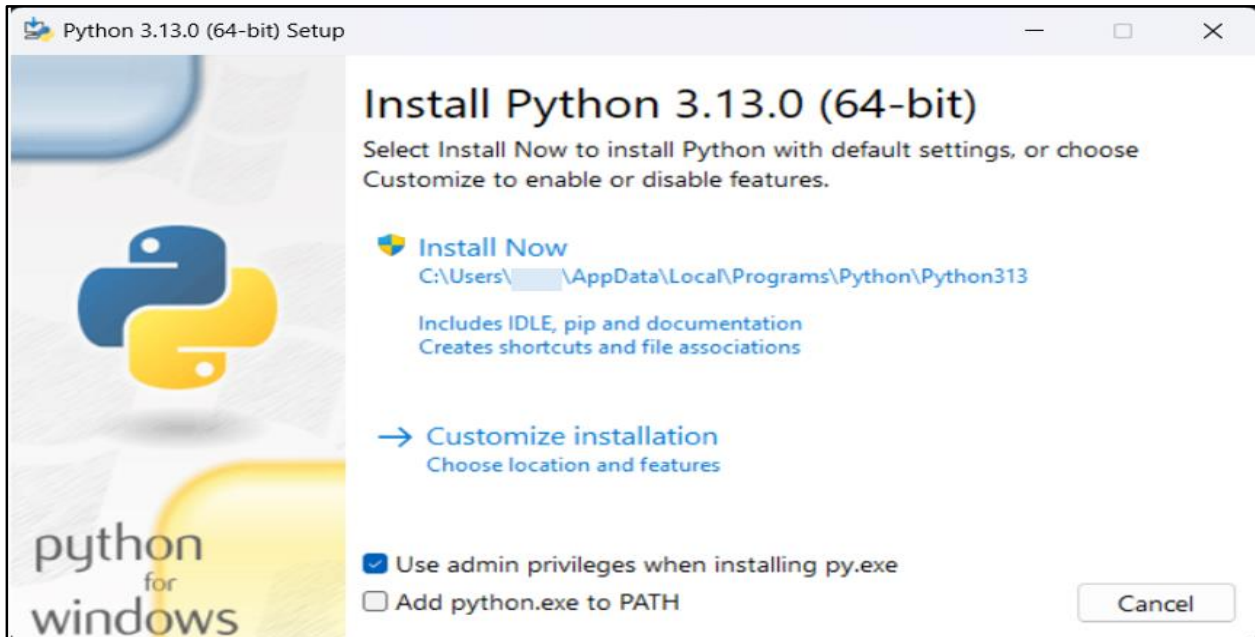

Self-assess

Go to the objectives at the beginning of the lesson.

Check the correct, I can..... box.

Learn by doing

Put a check mark (✓) in front of the correct sentence and a check mark (✗) in front of the incorrect sentence.

1. Python is a free and open-source language, which does not allow anyone to develop it. ()
2. It is not permissible to create applications and websites in Python. ()
3. Python uses data science and machine learning. ()
4. Python is an interpreted language because it translates programming codes line by line. ()
5. Python is used in developing web applications, data science, artificial intelligence, machine learning, and game programming. ()
6. Python is one of the most difficult programming languages. ()
7. Python can be integrated with other languages such as C, C++, and Java. ()
8. One of the disadvantages of Python is the lack of libraries that you can use. ()
9. NumPy: A library used in data science, statistics, and artificial intelligence. ()
10. Pandas: A library for analyzing and processing data. ()

- Download Python from the official website and arrange the following steps in the correct order.

- 1- You must choose 64bit or 32bit, depending on your device specifications.
- 2- Visit the official Python website www.python.org
- 3- Choose the system you are working on (Windows, Mac, or Linux).
- 4- After downloading, install the program on your device and follow the instructions.
- 5- Choose "Downloads"

Lesson 7

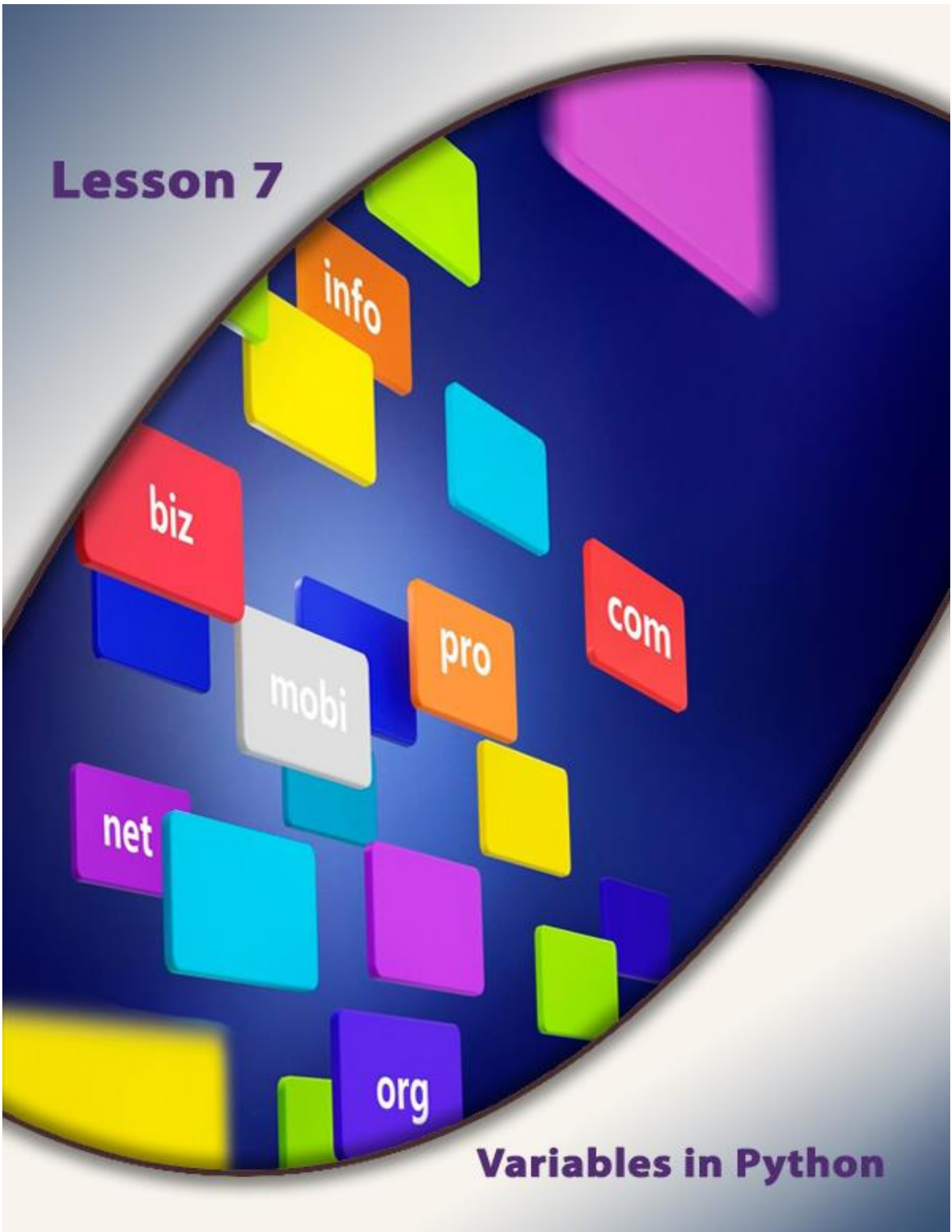

Variables in Python

Lesson7

Variables in Python

Objectives:

By the end of the lesson, I will be able to:

- Explain the concept of variables
- Deduce the types of variables
- Write a simple programming code in Python

After the lesson, check the correct box: I can...

- | | | |
|------------------------------------|-----------------------------|---|
| <input type="checkbox"/> Very good | <input type="checkbox"/> Ok | <input type="checkbox"/> Need more work |
| <input type="checkbox"/> Very good | <input type="checkbox"/> Ok | <input type="checkbox"/> Need more work |
| <input type="checkbox"/> Very good | <input type="checkbox"/> Ok | <input type="checkbox"/> Need more work |

Engage:

What are variables in programming languages? How can they be written and classified?

Learn

Variables in programming languages express a reserved place in memory to store and save a specific value, where the value can change (example: Taher= 20) In this example, we expressed a variable named (Taher) and its value is equal to (20), where you can change the value of the variable while dealing with the program immediately during the execution of the program.

Conditions for naming variables in Python:

1. The variable name begins with a letter or an underscore _.
2. The change name contains letters (A-Z) or numbers or an underscore _
3. Reserved words may not be used in Python because they express specific values that the program understands (example: False) A reserved word within the program is a word that indicates a reserved value (logical value).

Dear student... When writing a variable name, you must take into account placing the variable names in upper and lowercase letters (example: TAHER, Taher, taheR, TaheR) In the previous example, the variable names refer to four variables and not one variable.

Types of variables in Python

1- Numbers: Used to store numerical values such as integers (int) and decimals (float).

Integer variables:

X= 5

Y= 10

Decimal variables:

Z= 5.25

A= 8.32

2- Strings: Used to store texts such as names and addresses.

Texts are placed between single quotes ‘ ’ or double quotes “ ”

Name = “Taher”

City = ‘Cairo’

3- Booleans: A data type that contains only two values True or False

Often used in comparisons and decision making in codes

Is_taher_student = False

Is_taher_a_teacher = True

Python program interface

- 1- **Through the interactive Python interface (Python Shell):** You can write simple codes and execute them directly to see the results.

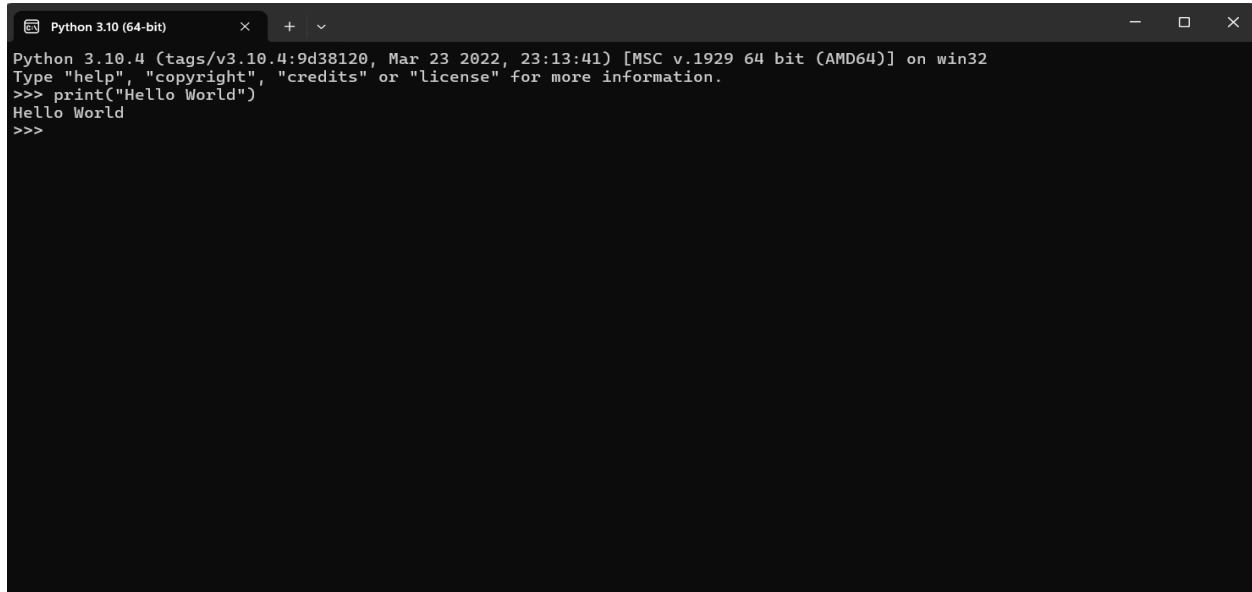

```
Python 3.10 (64-bit)
Python 3.10.4 (tags/v3.10.4:9d38120, Mar 23 2022, 23:13:41) [MSC v.1929 64 bit (AMD64)] on win32
Type "help", "copyright", "credits" or "license" for more information.
>>> print("Hello World")
Hello World
>>>
```

- 2- **Text editor:** It allows you to write longer and more complex codes and save them to run later.

The interactive Python interface is installed when you install the Python language, and there is no need to download it, unlike a text editor that must be downloaded from the Internet, such as Visual Studio and PyCharm.

To know the type of the variable you can use the type () function

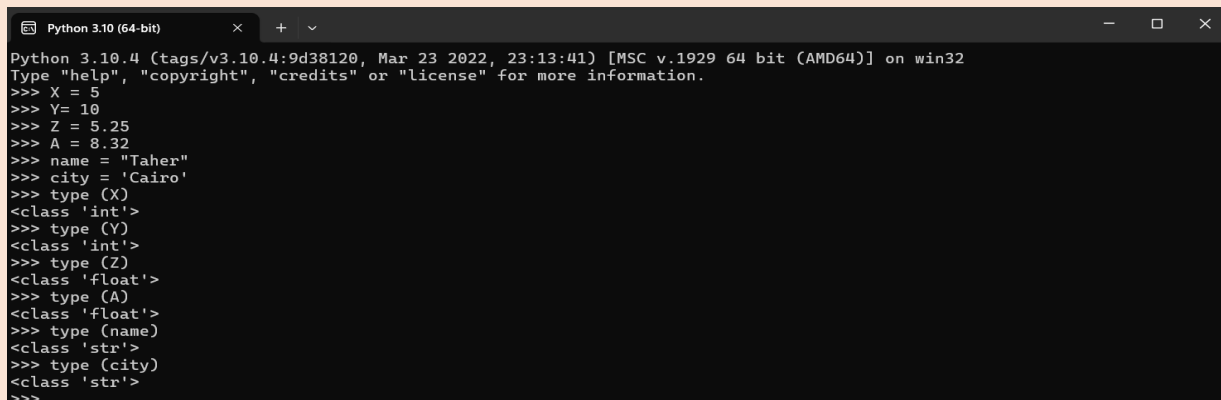

```
Python 3.10 (64-bit)
Python 3.10.4 (tags/v3.10.4:9d38120, Mar 23 2022, 23:13:41) [MSC v.1929 64 bit (AMD64)] on win32
Type "help", "copyright", "credits" or "license" for more information.
>>> X = 5
>>> Y = 10
>>> Z = 5.25
>>> A = 8.32
>>> name = "Taher"
>>> city = 'Cairo'
>>> type(X)
<class 'int'>
>>> type(Y)
<class 'int'>
>>> type(Z)
<class 'float'>
>>> type(A)
<class 'float'>
>>> type(name)
<class 'str'>
>>> type(city)
<class 'str'>
>>>
```

Simple Python Code Using Variables

```
Python 3.10 (64-bit) x + v
Python 3.10.4 (tags/v3.10.4:9d38120, Mar 23 2022, 23:13:41) [MSC v.1929 64 bit (AMD64)] on win32
Type "help", "copyright", "credits" or "license" for more information.
>>> name = "Omar"
>>> address = "Cairo, Egypt"
>>> age = 13
>>> print ("My name is", name)
My name is Omar
>>> print ("I live in", address)
I live in Cairo, Egypt
>>> print ("I am", age)
I am 13
>>>
```

The print function () in Python is one of the most commonly used functions, used to display text or values on the output screen. It can be used to display text, variables, or even the results of mathematical operations.

Self-assess

Go to the objectives at the beginning of the lesson.

Check the correct, I can..... box.

Learn by doing

Put a check mark (✓) in front of the correct sentence and a check mark (✗) in front of the incorrect sentence.

1. Variables in programming languages are a reserved place in memory to store and save a specific value. ()
2. The variable name must not begin with a letter or an underscore sign `_`. ()
3. TAHER, Taher, taheR, TaheR are 4 names for variables in the Python language. ()
4. The change name contains letters (A-Z) or numbers or an underscore sign `_`. ()
5. When naming variables, reserved words in the Python language may be used. ()
6. `Y= 10` The statement type of the variable Y is numeric for an integer. ()
7. `City = "Cairo"` The statement type of the variable City is text. ()
8. `Is_taher_student = False` The statement type of the variable `Is_taher_student` is logical. ()
9. To know the type of the variable, we do not need to use the `type()` function. ()
10. The texts of variables are placed between single quotation marks `' '` or double quotation marks `" "`. ()

- Choose the correct answer from the following.

1. The function is used to display texts or values on the output screen

- A. `Cos()`
- B. `Type()`.
- C. `Print()`.
- D. `Sin()`.

2. The text value of the variable is placed between the signs

- A. ""
- B. <>.
- C. >=.
- D. =<.

3. To display texts, variables, or even the results of mathematical operations, we use the function

- A. Cos()
- B. Type().
- C. Print().
- D. Sin().

4. To know the type of the variable statement, we use the function

- A. Cos()
- B. Type().
- C. Print().
- D. Sin().

Translation committee

Mr. Mostafa Zaghloul Ahmed
Central General supervisor of technical Education

Dr. Ghada Elsayed Mohamed
English Language curriculum Expert

Dr. Amira Fawzy Ahmed
Head of English Language Department

تطبيق



مذكرات جاهزة للطباعة

لتحميل الملفات التعليمية مجاناً للمعلم والطالب

مذكرات وملازم / مراجعات وملخصات / امتحانات / كتب الوزارة /
أدلة المعلم / دفاتر التحضير / سجلات مدرسية / أوراق تأسيس

امسح الكود بموبايلك علشان تقدر تثبت التطبيق

وتقدر ف أي وقت تحمّل ال نفسك فيه ببلاش

هيغنيك عن البحث والجروبات والقنوات الكثيرة

